

Buffet Collections

EU 2024



THE ART OF PRESENTATION



THE ART OF PRESENTATION



a passion to inspire

Steelite International is the leading designer, marketer, manufacturer, and supplier of award-winning tabletop, buffet and lighting solutions for the global hospitality industry. Dual headquarters, located in New Castle, PA, and Stoke-On-Trent, UK, along with a 500,000 square foot manufacturing facility and fourteen showrooms worldwide, enables us to service over 140 countries for more than 50 years. We are committed to providing the best in functionality and design while minimising the effect on our environment. For more information, please visit www.steelite.com.

the steelite experience

Customer satisfaction requires dedication, commitment and a passion to achieve levels of excellence far exceeding expectation.

Elevate the buffet experience with Collections Buffet from Steelite International. Alongside our core & partner brands, Steelite has carefully curated an assortment of buffet products which can be found on the subsequent pages.

We look forward to serving you!

showrooms

Steelite Showrooms provide the perfect opportunity to explore our vast portfolio, and our knowledgeable sales team will offer a solution for any tabletop concept. We are proud to have showrooms in these locations:

- | | |
|--|---|
| <p>UK</p> <ul style="list-style-type: none"> • London • Stoke-on-Trent <p>EU</p> <ul style="list-style-type: none"> • Bickenbach, Germany • Madrid, Spain <p>ASIA</p> <ul style="list-style-type: none"> • Hong Kong <p>AUS</p> <ul style="list-style-type: none"> • Sydney, NSW | <p>US</p> <ul style="list-style-type: none"> • Atlanta, Georgia • Chicago, Illinois • Los Angeles, California • Miami, Florida • New York, New York • Washington, D.C. • Youngstown, Ohio <p>CA</p> <ul style="list-style-type: none"> • Toronto, Ontario |
|--|---|

a truly global enterprise

With a wide range of products, Steelite offers a unique solution for any venue from commercial catering to leisure and hospitality markets, the opportunities are endless with our vast product portfolio.

Steelite core brands include Steelite Distinction & Performance, William Edwards, D.W. Haber, Creations, Folio, Varick, Homer Laughlin, Hall China, Diversified Ceramics, Hollowick, Walco, Aspen Drinkware, and Kenny Mack Designs. In addition to our core brands, we distribute the following prominent brands: Anfora, Bormioli Rocco, Catherine Hurand, Delfin, Fiesta, Genware London, Hepp, Jean Dubost, La Tavola, Maham Studio, MCC, Modern Mixologist, Modern-Twist, Mogogo, MyGlassStudio, Nude, Pasabahce, Pillivuyt, RCP Design, RCR Cristalleria, Rene Ozorio, Robert Gordon Pottery, Robert Welch, Rona 5-Star Glass, Roselli, Royal Porcelain, Strahl, Trudeau, Utopia Tableware, Williamsburg Metalworks, and WNK.





Customer Testimonial

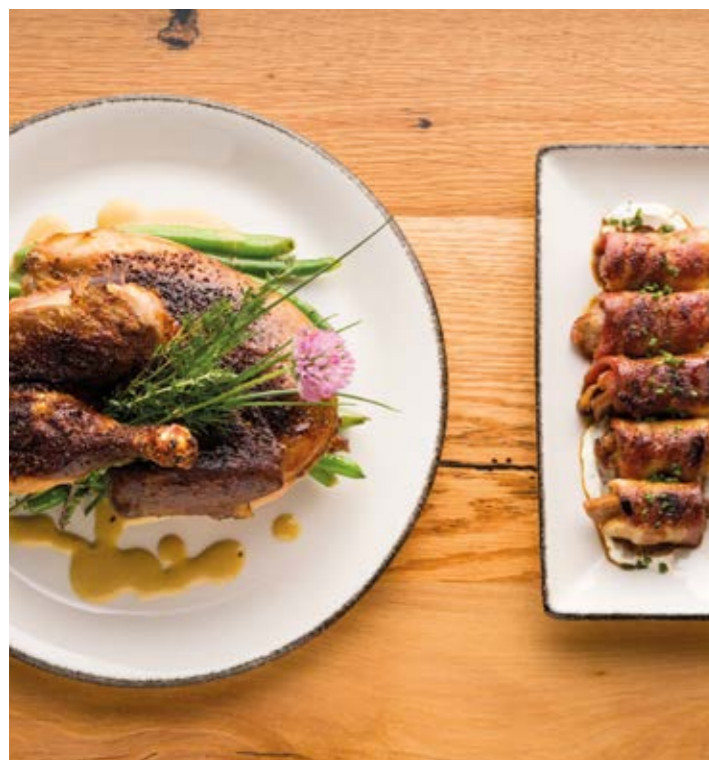

Brian Landry Chef/Owner QED Hospitality
The Kitchen Table Clermont, KY

Our restaurant, The Kitchen Table, is located on the Kentucky Bourbon Trail. When opening our restaurant, we wanted pieces that were upscale and comfortable, pieces that would highlight the nature of the bourbon trail. The Steelite products we selected are the perfect balance between high-end quality and comfort.



Customer Testimonial



Jorge L. Feliz German President Karisma Dominicana & General Director
Karisma Hotels & Resorts Punta Cana

In collaboration with Steelite, we developed a dinnerware and glassware product guide that is used for all of our restaurant concepts globally. The product catalog complements our Gourmet Inclusive Concept and allows us to provide a unique experience for our guests.

Table of Contents

| | | | | | | | | | | | |
|---|-----------|--|-----------|---|-----------|------------------------------------|------------|--|------------|--|------------|
| <i>chafers, marmites & heater stands</i> | 12 | <i>heating lamps & carving boards</i> | 48 | <i>induction, chafing fuel & burners</i> | 74 | <i>platters & bowls</i> | 136 | <i>hollowware & accessories</i> | 158 | <i>serving utensils & accessories</i> | 170 |
| ROLLTOP CHAFERS | | HEATING LAMPS | | INDUCTION RANGES | | FOLIO | | ROBERT WELCH | | D.W. HABER | |
| D.W. Haber | 16 | Creations | 52 | D.W. Haber Power Cell | 76 | Alpha-Ceram Buffet | 138 | Drift | 160 | Serving Utensils | 172 |
| HINGED CHAFERS | | CARVING BOARDS | | D.W. Haber | 78 | CREATIONS MELAMINE | | D.W. HABER | | ROBERT WELCH | |
| D.W. Haber | 18 | D.W. Haber | 54 | CHAFING FUEL & BURNERS | | Pompeii Buffet | 140 | Tower | 162 | Radford | 174 |
| Creations | 22 | <i>beverage & cereal dispensers</i> | 56 | Hollowick | 80 | Gastronorm Trays | 142 | Traditional & Tear Drop | 163 | Signature | 175 |
| Walco | 24 | COFFEE URNS & AIRPOTS | | <i>custom powder coating</i> | 84 | Craft | 144 | Accessories | 164 | FOLIO | |
| MARMITES | | D.W. Haber | 60 | <i>visual display</i> | 88 | Quarry | 146 | KENNY MACK | | Bryce | 176 |
| D.W. Haber | 30 | JUICE DISPENSERS | | D.W. HABER | | Scape | 148 | Spoon Rests | 165 | Angle | 177 |
| HEATER STANDS | | D.W. Haber | 62 | Fusion Buffet System | 106 | KENNY MACK RESIN | | CREATIONS | | WALCO | |
| D.W. Haber | 32 | Touchless Taps | 64 | Fusion Risers & Tiles | 114 | Cameron | 150 | Metal Accessories | 166 | Serving Utensils | 178 |
| HOMESTYLE CHAFERS | | Creations | 65 | Fusion Buffet System Overview | 116 | Wave | 152 | Royce | 168 | MODERN-TWIST | |
| D.W. Haber | 34 | MILK & CEREAL DISPENSERS | | Fusion Inserts & Accessories | 124 | Jagged Edge & Bark | 154 | WILLIAMSBURG METALWORKS | | Placemats, Runners & Trivets | 180 |
| Creations | 40 | D.W. Haber | 66 | Presentation Tiered Displays | 126 | Trays | 155 | Trays | 169 | <i>care & use</i> | 182 |
| COOKWARE & BAKEWARE | | Creations | 67 | CREATIONS | | Bowls | 156 | | | | |
| Folio Cookware | 42 | CHILLERS, COOLERS & COFFEE POURERS | | Wood Buffet Display | 128 | | | | | | |
| Craft Cookware | 44 | D.W. Haber | 68 | Display Stands | 130 | | | | | | |
| Simplicity Cookware | 45 | Creations | 70 | | | | | | | | |
| FOOD PANS & INSERTS | | Robert Welch | 71 | RISERS | | | | | | | |
| Hall China | 46 | ACCESSORIES | | Folio Roselli Resin Risers | 132 | | | | | | |
| | | Kenny Mack | 72 | Roselli Porcelain Risers | 134 | | | | | | |
| | | | | KENNY MACK | | | | | | | |
| | | | | Carved & Smooth Risers | 135 | | | | | | |





Chafers, Marmites & Heater Stands

Create a visual impact by separating the ordinary from the extraordinary in buffet. Steelite International shares your passion for excellence in catering through superior offerings in chafers, marmites, and heater stands.

This section highlights all induction-capable and traditional fuel units.



Steelite Performance
Ink Nomad Blue
17620566
Coupe Plate
D 25.25cm (10")

Rona Eclipse
480138R002 ●
Juice Tumbler
(12¼oz)
Not available in
the EMEA

D.W. Haber
DW08H40KGBK ●
Black Tower Heater Stand w/Grill
101.6cm x 35.6cm (L 40" W 14")

Hollowick
HWEZ638 ●
Easy Heat 6-3-8 Hour Chafing Fuel

Creations Homestyle Chafer
7353MW301 ●
Round Antique Brushed Bronze
3.8L (4qts)
38.1 x 31.8 x 12.7cm H
(15" x 12½" x 5" H)

Steelite Performance
Ink Nomad Blue
17620569
Coupe Bowl
25.25cm (D 10" H 1½")
120.25cl (42.3oz)

Varick 18/0
5735SX
Fulton Vintage Copper

Creations Wood
6525T192 ●
Acacia Bread Board Paddle
(L 17" W 8")

Steelite Performance
Aurora Vesuvius
17820481
Bowl
13.5cm (D 5¼") 45.5cl (16oz)



cleverly designed for your buffet presentation

D.W. Haber's Rolltop Chafers feature the acclaimed patented balance-cover mechanism which prevents the lid from slamming back. These stainless steel vessels have a clever condensation return which returns water back to the water pan. The chafers work well in any buffet occasion, and pair perfectly with the hinged and liftoff-lid marmites. Available in Tempo or Millennium, D.W. Haber chafers pair with a wide variety food pans to accommodate your foodservice needs.



Tempo Rectangular Rolltop Chafers
DW78RFWSS ●
71.1cm (L 28" W 22" H 15")
7.5L (8qt) (G/N 1/1)



Tempo Round Rolltop Chafers
DW76RFWSS ●
53.3cm (L 21" W 21" H 20") 7.5L (2gal)

millennium



Millennium Rectangular Rolltop Chafers
DW78RFDSC ●
67.3cm (L 26½" W 19" H 19½")
7.5L (8qt) (G/N 1/1)



Millennium Round Rolltop Chafers
DW76RFDSC ●
55.9cm (L 22" W 22" H 19") 7.5L (2gal)

food pans



Food Pan
DW06RFP4
38.7cm (D 15¼" H 3") 7.5L (2gal)
For 5.7L/2gal Round



Divided Food Pan
DW06RFP2
38.7cm (D 15¼" H 3") 7.5L (2gal)
For 5.7L/2gal Round



Half Round Food Pan
DW06RFP22 ●
38.1cm (L 15" W 6½" H 3")
7.5L (2gal) For 5.7L/2gal Round
Spacer Bar
DW06RFP22BAR ●
For Half Round Food Pan
37.5cm (L 14¾" W ¾" H ¾")



Rectangular Food Pan
DW08RFP
54.6cm (L 21½" W 13" H 2¾")
7.5L (8qt)
For 2 gal Rectangle Chafers



Porcelain Food Pan
DW06RFP4POR
38.7cm (D 15¼" H 3") 7.5L (2gal)
For 5.7L/2gal Round



S Divided Porcelain Food Pan
DW06RFP2SPOR ●
38.7cm (D 15¼" H 3") 7.5L (2gal)
For 5.7L/2gal Round



Shallow Round Food Pan
DW06RFP3 ●
38.7cm (D 15¼" H 1")
For 2 gal Round Chafers

Pair with Hollowick Chafing Fuels. See pages 80-83 for more information.

HWEZ425 ● Easy Heat 4-2-5 Hour • **HWPLUS4** ● Ready Heat Plus 4 Hour • **HWREADY4** ● Ready Heat 4 Hour • **HWBUFF4** ● Buffet Heat 4 Hour

All chafers include a stainless steel food pan.

D=Diameter L=Length W=Width H=Height • All Products are Measured at Max Capacity (oz)

● Non-Stock

Backed by D.W. Haber's warranty

- Patented hinge effortlessly stops in any position
- Removable lid for ease of cleaning
- Compatible with induction, heater stands, or chafer frames
- Available with a solid or full glass lid
- Built-in condensation system that returns condensation back into the water pan



patented hinge effortlessly stops in any position

Elevate your buffet service with D.W. Haber's Hinged Chafers. With the capability to work on induction, heater stands, or chafer frames, these chafing dishes feature a clever, patented hinge that will stop the lid in any position, making it the ultimate choice for foodservice. These vessels are available with a solid or full glass lid, and have a unique built-in condensation system that returns condensation back in to the water pan.



Power Cell Cordless Induction Range - Patent-Pending
 220V EU & UK Plug
DWELINPCE2E3 • L 37.1cm x W 33.0cm (L 14⁵/₈" W 13" H 3")
 Page 76



induction



Round Induction Chafer Full Glass Lid
DW06WGH7SS 50.8cm (L 20" W 16" H 6") 7.5L (2gal)
DW04WGH7SS 40.6cm (L 16" W 13" H 6") 3.8L (4qt)



Round Induction Chafer
DW06WGHSS 46.4cm (L 18½" W 15¾" H 6") 7.5L (2 gal)
DW04WGHSS 31.8cm (L 12½" W 15½" H 5¾") 3.8L (4qt)



Round Hammered Induction Chafer
DW06WGHMSS 46.4cm (L 18½" W 15¾" H 6") 7.5L (2gal)



Tempo Rectangular Chafer
DW08QWHSS
 61.6cm (L 24¼" W 14¾" H 12") 7.5L (2gal)
 (G/N 1/1)



Tower Rectangular Chafer
DW08QKHSS
 61.6cm (L 24¼" W 14¾" H 12") 7.5L (2gal)
 (G/N 1/1)



Millennium Rectangular Chafer
DW08QDHSS
 61.6cm (L 24¼" W 15" H 12") 7.5L (2gal)
 (G/N 1/1)

free-standing

free-standing



Tempo Round Chafer Full Glass Lid
DW06WH7SS 45.7cm (L 18" W 18½" H 12") 7.5L (2gal)
DW04WH7SS 38.1cm (L 15" W 15¼" H 11") 3.8L (4qt)



Tempo Round Chafer
DW06WHSS 45.7cm (L 18" W 18½" H 12") 7.5L (2gal)
DW04WHSS 38.1cm (L 15" W 15¼" H 11") 3.8L (4qt)



Saturn Hammered Round Hinged Chafer
DW06UHMSS
 46.4cm (L 18¼" W 15¾" H 12½") 7.5L (2gal)



Tower Round Chafer Full Glass Lid
DW06KH7SS 44.5cm (L 17½" W 18" H 12") 7.5L (2gal)
DW04KH7SS 38.1cm (L 15" W 15¼" H 11") 3.8L (4qt)



Tower Round Chafer
DW06KHSS 44.5cm (L 17½" W 18" H 12") 7.5L (2gal)
DW04KHSS 38.1cm (L 15" W 15¼" H 11") 3.8L (4qt)



Saturn Round Hinged Chafer
DW06UHSS
 46.4cm (L 18¼" W 15¾" H 12½") 7.5L (2gal)



Millennium Round Chafer Full Glass Lid
DW06DH7SS 47.0cm (L 18½" W 16" H 12") 5.7L (2gal)
DW04DH7SS 38.7cm (L 15¼" W 15" H 11") 3.8L (4qt)



Millennium Round Chafer
DW06DHSS 47.0cm (L 18½" W 16" H 12") 5.7L (2gal)
DW04DHSS 38.7cm (L 15¼" W 15" H 11") 3.8L (4qt)

food pans



Food Pan
DW06RFP4
 38.7cm (D 15¼" H 3") 7.5L (2gal)
 For 5.7L/2gal Round
DW64RFP
 30.2cm (L 11⅞" W 11⅞" H 2¾")
 3.8L (4qt) For 3.8L/4qt Round



Divided Food Pan
DW06RFP2
 38.7cm (D 15¼" H 3") 7.5L (2gal)
 For 5.7L/2gal Round
DW64RFP2
 30.5cm (L 12" W 12" H 3") 3.8L (4qt)
 For 3.8L/4qt Round



Half Round Food Pan
DW06RFP22
 38.1cm (L 15" W 6½" H 3")
 7.5L (2gal) For 5.7L/2gal Round
 Spacer Bar
DW06RFP22BAR
 For Half Round Food Pan
 37.5cm (L 14¾" W ¾" H ¾")



Rectangular Food Pan
DW08FP
 54.6cm (L 21½" W 13" H 2¾")
 7.5L (8qt)
 For 2 gal Rectangle Chafer



White Porcelain Food Pan
DW06RFP4POR
 38.7cm (D 15¼" H 3") 7.5L (2gal)
 For 5.7L/2gal Round
DW64RFP4POR
 30.5cm (D 12" H 2¾") 3.8L (4qt)
 For 3.8L/4qt Round



White S Divided Porcelain Food Pan
DW06RFP2SPOR
 38.7cm (D 15¼" H 3") 7.5L (2gal)
 For 5.7L/2gal Round



Black Porcelain Round Food Pan
DW64RFP4PORBK
 30.5cm (D 12" H 2¾") 3.8L (4qt)
 For 3.8L/4qt Round



Shallow Round Food Pan
DW06RFP3
 38.7cm (D 15¼" H 1")
 For 2 gal Round Chafer

Pair with Hollowick Chafing Fuels. See pages 80-83 for more information.

HWEZ425 • Easy Heat 4-2-5 Hour • **HWPLUS4** • Ready Heat Plus 4 Hour • **HWREADY4** • Ready Heat 4 Hour • **HWBUFF4** • Buffet Heat 4 Hour

All chafers include a stainless steel food pan.

D=Diameter L=Length W=Width H=Height • All Products are Measured at Max Capacity (oz)

• Non-Stock • Stocked In European Warehouse



Round Chafing Dish And Stand
7351MW107 ●
47.6 x 42.5 x 30.4cm (18¾" x 16¾" x 12")
9.1L (2gal)
Round Chafing Dish
7351MW102
47.6 x 42.5 x 19.0cm H (18¾" x 16¾" x 7½" H)
9.1L (2gal)
Round Chafing Dish Stand
7351MW103
30.4 x 39.3 x 16.5cm H (12" x 15½" x 6½" H)



Rectangular Chafing Dish w/Stand
7351MW100
57.2 x 43.2 x 29.8cm H (22½" x 17" x 11¾" H)
7.6L (8qts)



Square Chafing Dish and Stand
7351MW106 ●
32.4cm x 31.1cm (12¾" x 12¼") 5.7L (6qts)
Square Chafing Dish
7351MW104 ●
38.7 x 43.2 x 17.1cm H (15¼" x 17" x 6¾" H)
5.7L (6qts)
Square Chafing Dish Stand
7351MW105 ●
32.4 x 31.1 x 16.5cm H (12¾" x 12¼" x 6½" H)
Square Chafing Dish Food Pan
7351MW108 ●
32.4 x 35.6 x 6.4cm H (L 12¾" W 14" H 2½")
5.7L (6qts)

Pair with Hollowick Chafing Fuels. See pages 80-83 for more information.

HWEZ425 ● Easy Heat 4-2-5 Hour • **HWPLUS4** ● Ready Heat Plus 4 Hour • **HWREADY4** ● Ready Heat 4 Hour • **HWBUFF4** ● Buffet Heat 4 Hour

food pans



Food Pan
DW06RFP4
38.7cm (D 15¼" H 3") 7.5L (2gal)
For 5.7L/2gal Round



Divided Food Pan
DW06RFP2
38.7cm (D 15¼" H 3") 7.5L (2gal)
For 5.7L/2gal Round



Half Round Food Pan
DW06RFP22 ●
38.1cm (L 15" W 6½" H 3")
7.5L (2gal) For 5.7L/2gal Round
Spacer Bar
DW06RFP22BAR ●
For Half Round Food Pan
37.5cm (L 14¾" W ¾" H ¾")



Rectangular Food Pan
DW08FP
54.6cm (L 21½" W 13" H 2¾")
7.5L (8qt)
For 2 gal Rectangle Chafer



Porcelain Food Pan
DW06RFP4POR
38.7cm (D 15¼" H 3") 7.5L (2gal)
For 5.7L/2gal Round



S Divided Porcelain Food Pan
DW06RFP2SPOR ●
38.7cm (D 15¼" H 3") 7.5L (2gal)
For 5.7L/2gal Round



Shallow Round Food Pan
DW06RFP3 ●
38.7cm (D 15¼" H 1")
For 2 gal Round Chafer



Square Food Pan
7351MW108 ●
32.4 x 35.6 x 6.4cm H
(L 12¾" W 14" H 2½") 5.7L (6qts)
(For 6 qt Square Chafer)

chafing dishes at a phenomenal price point

We are pleased to bring hydraulic closing chafing dishes to the Creations collection. Each chafer has a conveniently large glass view in the lid to increase visibility of the food. This features allows for fewer opens, thus keeping the heat in and the food remains at proper serving temperature. Additionally, the easy-to-remove hydraulic lid closes on its own to ensure that food is kept safe and covered during service. Great for any buffet display, these chafers are induction capable and perfectly priced for even the most value-conscious operators.

All chafers include a stainless steel food pan.

D=Diameter L=Length W=Width H=Height • All Products are Measured at Max Capacity (oz)

● Non-Stock ● Stocked in European Warehouse



designed to withstand the rigours of constant buffet use

Available with glass or metal lid

Inside cover drip channel collects condensation back into the water pan and not the food pan

3-layer induction

The outside layer is magnetic stainless, which is most efficient when used with the induction heating process. The middle layer is aluminium which spreads heat out evenly. The inside layer is 18/10 stainless, the best for resisting stains.

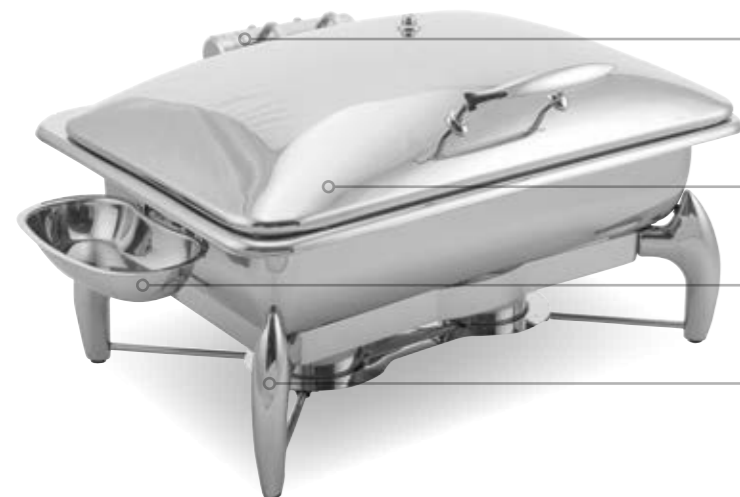

Hinged & self closing lid

Removable lid for easy cleaning

Includes food pan and spoon holder

Separating stand for Hollowick chafing fuel

heralded as the leading induction ready chafer in the market

Enhance any buffet presentation with induction ready chafers by Walco. Idol™ chafing dishes are made of high-quality 18/10 stainless steel and are designed to withstand the rigours of foodservice. With the ability to use each chafer on induction or set on a stand to warm with chafing fuel, Walco Idol™ chafers include a built-in holder for a spoon rest to make service simple & convenient. The chafing dishes are also available with a removable, solid stainless lid or glass, to allow customers to effectively see the contents without lifting the lid and releasing heat. Create a visual impact that's sure to impress with Walco chafers.

induction



Idol™ Hinged Round Chafer Body w/Metal Lid
WLWIGUMT ●
L 21" W 18½" H 10¼" (7qt)
Includes SS food pan and spoon holder



Idol™ Hinged Round Chafer Body w/Glass Top Lid
WLWI6UGT ●
L 21" W 18½" H 10¼" (7qt)
WLWI4UGT ●
L 17¾" W 15½" (4qt)
Includes SS food pan and spoon holder

free-standing



Idol™ Hinged Round Chafer Kit w/Metal Lid
WLWIGLML ●
L 21" W 18½" H 16½" (7qt)
Includes SS food pan, spoon holder, burner stand and fuel cup



Idol™ Hinged Round Chafer & Stand w/Glass Top Lid
WLWI6LGL ●
L 21" W 18½" (7qt)
WLWI4LGL ●
L 18¾" W 15½" (4qt)
Includes SS food pan, spoon holder, burner stand and fuel cup

Pair with Hollowick Chafing Fuels. See pages 80-83 for more information. All chafers include a stainless steel food pan.
HWEZ638 ● Easy Heat 6-3-8 Hour • **HWPLUS6** ● Ready Heat Plus 6 Hour • **HWREADY6** ● Ready Heat 6 Hour • **HWBUFF624** ● Buffet Heat 6 Hour
D=Diameter L=Length W=Width H=Height • All Products are Measured at Max Capacity (oz)



induction



Idol™ Hinged Rectangle Chafer Body w/Metal Lid
WLW19UMT ●
L 23¾" W 18½" H 10½" (8qt)
Includes SS food pan and spoon holder



Idol™ Hinged Rectangle Chafer Body w/Metal Lid
WLW155UMT ●
L 21" W 12¾" (6qt)
Includes SS food pan and spoon holder



Idol™ Hinged Rectangle Chafer Body w/Metal Lid
WLW135UMT ●
L 18½" W 13½" H 10¼" (4qt)
Includes SS food pan and spoon holder



Idol™ Hinged Rectangle Chafer Body w/Glass Top Lid
WLW19UGT ●
L 23¾" W 18½" H 10½" (8 qt)
Includes SS food pan and spoon holder



Idol™ Hinged Rectangle Chafer Body w/Glass Top Lid
WLW155UGT ●
L 17¼" W 16" H 9" (6 qt)
Includes SS food pan and spoon holder



Idol™ Hinged Rectangle Chafer Body w/Glass Top Lid
WLW135UGT ●
L 18½" W 13½" H 10¼" (4 qt)
Includes SS food pan and spoon holder

free-standing



Idol™ Hinged Rectangle Chafer Kit w/Metal Lid
WLW19LML ●
L 23" W 18½" H 16¾" (8qt)
Includes SS food pan, spoon holder,
burner stand and fuel cups



Idol™ Hinged Rectangle Chafer Kit w/Metal Lid
WLW155LML ●
L 18½" W 17" H 16¼" (6qt)
Includes SS food pan, spoon holder,
burner stand and fuel cup



Idol™ Hinged Rectangle Chafer Kit w/Metal Lid
WLW135LML ●
L 18½" W 13½" H 16¼" (4qt)
Includes SS food pan, spoon holder,
burner stand and fuel cup



Idol™ Hinged Rectangle Chafer Kit w/Glass Top Lid
WLW19LGL ●
L 23" W 11½" H 6¼" (8qt)
Includes SS food pan, spoon holder,
burner stand and fuel cups



Idol™ Hinged Rectangle Chafer Kit w/Glass Top Lid
WLW155LGL ●
L 18¼" W 17" H 16¼" (6qt)
Includes SS food pan, spoon holder,
burner stand and fuel cup



Idol™ Hinged Rectangle Chafer Kit w/Glass Lid
WLW135LGL ●
L 18½" W 13½" H 16½" (4qt)
Includes SS food pan, spoon holder,
burner stand and fuel cup



NSF certified and loaded with great features

Tested & approved by the NSF organisation, the Walco Idol™ NSF Chafer has an induction ready bottom and a slow closing hinge that ensures the lid will not slam shut during operation. A “dripless” design with ventilation allows condensation on the lid to flow back into the water pan as opposed to on the countertop. With built-in grooves for an NSF-approved serving spoon and tongs, service is convenient, handles won't fall into the food, and the lid closes perfectly to keep the heat in.



Idol™ NSF Chafer
WLW155BODY ●
L 21" W 12¾" (6qt)
Food Pan Sold Separately



Idol™ NSF 18/10 Stainless Steel
Rectangle Food Pan
WL8232CT ●
L 14" W 12¾" (6qt)



Idol™ NSF Curved
Handle Serving Spoon
WLWL01B ●
11⅜"



Idol™ NSF
Bacon Tongs
WL74149B ●
L 9"



induction



Idol™ Hinged Soup Station Body w/Glass Top Lid
WLW11UGT ●
L 17" H 15" (11½qt)
Includes SS food pan and spoon holder



free-standing

Idol™ Hinged Round Soup Station Kit w/Glass Top Lid
WLW11LSSGL ●
L 19¼" W 15" H 19" (11½qt)
Includes SS food pan, spoon holder, burner stand and fuel cup

Pair with Hollowick Chafing Fuels. See pages 80-83 for more information. All chafers include a stainless steel food pan.
HWZ638 ● Easy Heat 6-3-8 Hour • **HWPLUS6** ● Ready Heat Plus 6 Hour • **HWREADY6** ● Ready Heat 6 Hour • **HWBUFF624** ● Buffet Heat 6 Hour

idol™ chafers storage

protect any of your chafers with these hard plastic containers



Collapsible Storage Box **WLBOXCLG01** ● L 18½" W 27¾" H 20½"



Rectangle Chafers Box **WLBOXLG01** ● L 30"



4-6 quart options



Idol™ 18/10 Stainless Steel Round Food Pan
WL532508 ●
D 14" H 3" (4qt)



Idol™ 18/10 Stainless Steel Rectangle Food Pan NSF
WL8232CT ●
L 14" W 12¼" (6qt)



Idol™ Porcelain Round Food Pan
WLW14P ●
L 12½" W 12½" (4qt)



Idol™ Porcelain Rectangle Food Pan
WLW135P ●
L 12¾" W 10½" H 2½" (4qt)



Idol™ Porcelain Rectangle Food Pan
WLW155P ●
L 21" W 12¾" H 2½" (6qt)

7-8 quart options



Idol™ 18/10 Stainless Steel Round Food Pan
WLW1608 ●
D 16¾" (7qt)



Idol™ 18/10 Stainless Steel Divided Food Pan
WLW1608D ●
D 16¾" (7qt)



Idol™ Porcelain Round Food Pan
WL53316 ●
D 15¾" H 2½" (8qt)



Idol™ Porcelain Round Divided Food Pan
WL53316D ●
D 15¾" H 2½" (7qt)



Idol™ Porcelain Rectangle Food Pan
WLW19P ●
L 21" W 12½" H 2½" (8qt)

12 quart options



Idol™ 18/10 Stainless Steel Deep Rectangle Food Pan
WLW19DSP ●
L 21" W 12½" H 3" (12qt)

soup station options



Idol™ 18/10 Stainless Steel Soup Bucket
WLW11SB ●
D 11¼" H 10½" (11½qt)

food pan gripper

the ultimate food pan removing tool

It protects hands and fingers from burns. It will pry, grip, lift and assist in carrying your food pan from a chafing dish or a steam table. The food pan gripper is also dishwasher safe for easy cleaning.



Food Pan Gripper 18/10 Stainless Steel
WLPANGRIP ●
L 7¾" W 2" H 4"



tempo



Tempo Hinged Marmite
DW06SWHSS ●
31.1cm
(L 12¼" W 11¼" H 19½")
5.7L (6qt)
Tempo Lifftoff Marmite
DW06SWSS ●
31.1cm
(L 12¼" W 11¼" H 19½")
5.7L (6qt)



Tempo Hinged Marmite
DW04SWHSS ●
25.4cm (L 10" W 8¾" H 19")
3.8L (4qt)
Tempo Hinged Marmite
DW02SWHSS ●
1.9L (2qt)



Tempo Lifftoff Chafer
DW01QWSS ●
23.5cm (L 9¼" W 9¼" H 9")
0.95L (1qt)

tower



Tower Hinged Marmite
DW06SKHSS ●
27.3cm
(L 10¾" W 11¼" H 19")
5.7L (6qt)
Tower Lifftoff Marmite
DW06SKSS ●
27.3cm
(L 10¾" W 11¼" H 19")
5.7L (6qt)



Tower Hinged Marmite
DW04SKHSS ●
23.5cm (L 9¼" W 8¾" H 18")
3.8L (4qt)
Tower Hinged Marmite
DW02SKHSS ●
1.9L (2qt)



Tower Lifftoff Chafer
DW01QHSS ●
23.5cm (L 9¼" W 9¼" H 9")
0.95L (1qt)

millennium



Millennium Hinged Marmite
DW06SDHSS ●
29.8cm
(L 11¼" W 10¼" H 19½")
5.7L (6qt)
Millennium Lifftoff Marmite
DW06SDSS ●
29.8cm
(L 11¼" W 10¼" H 19½")
5.7L (6qt)



Millennium Hinged Marmite
DW04SDHSS ●
25.4cm (L 10" W 8¾" H 19")
3.8L (4qt)
Millennium Hinged Marmite
DW02SDHSS ●
(L 18" W 10") 1.9L (2qt)



Millennium Lifftoff Chafer
DW01QDSS ●
23.5cm (L 9¼" W 9¼" H 9½")
0.95L (1qt)

marmite inserts



Insert Pan Petite Marmite w/
Socket SS
DW06SINSHSS ●
25.4cm (L 10" W 9½" H 8½")
5.7L (6qt)



Insert Pan Petite Marmite SS
DW06SINSSS ●
24.1cm (L 9½" W 9½" H 8½")
5.7L (6qt)



Insert Pan Marmite Hinged SS
DW04SINSHSS ●
(L 7½" W 7¼" H 8¼")
3.8L (4qt)



Insert Pan Marmite Hinged SS
DW02SINSHSS ●
(D 6" H 7½")
1.9L (2qt)



Round Food Pan
DW01QFP ●
(For 1qt Lifftoff Chafer)
.95L

durable with efficient heating performance

D.W. Haber Marmites are the perfect choice for chefs and foodservice professionals who demand high-quality buffetware. These marmites are designed as a double boiler to provide efficient and reliable heating performance without burning, while also being durable and easy to clean. With their heavy-duty, welded stainless steel construction, D.W. Haber Marmites are built to withstand the rigours of commercial kitchen environments. The vessels also feature a sleek & modern design that is available with a hinged cover option and 3 recognisable leg shapes – round Tempo, square Tower, and classically elegant Millennium. Whether you are simmering soups, stews, or sauces, D.W. Haber Marmites are the ideal choice for buffet service.

Pair with Hollowick Chafing Fuels. See pages 80-83 for more information.
LIFTOFFS: **HWEZ425** ● Easy Heat 4-2-5 Hour • **HWPLUS4** ● Ready Heat Plus 4 Hour • **HWREADY4** ● Ready Heat 4 Hour • **HWBUFF4** ● Buffet Heat 4 Hour
MARMITES: **HWEZ638** ● Easy Heat 6-3-8 Hour • **HWPLUS6** ● Ready Heat Plus 6 Hour • **HWREADY6** ● Ready Heat 6 Hour • **HWBUFF624** ● Buffet Heat 6 Hour

All marmites include a stainless steel insert.
D=Diameter L=Length W=Width H=Height • All Products are Measured at Max Capacity (oz) ● Non-Stock



custom action stations

The heater stands by D.W. Haber are the ultimate 'wow' factor for your action stations. Available in 20" and 40" sizes, these stands can be customised with a carving board, grill or aluminium insert, and provide the perfect surface for keeping your food warm.

tempo



Tempo Heater Stand w/Grill
DW08H40WGSS ●
101.6cm x 35.6cm (L 40" W 14")
Chafers sold separately



Tempo Heater Stand w/Grill
DW04H202WGSS ●
50.8cm x 35.6cm (L 20" W 14")
Chafers sold separately

Tempo Heater Stand w/Aluminium
DW08H40WSS ●
101.6cm x 35.6cm (L 40" W 14")

Tempo Heater Stand w/Aluminium
DW04H202WSS ●
50.8cm x 35.6cm (L 20" W 14")



Maple Carving Board
DW04H202CB34 ●
50.8 x 30.5 x 1.9cm H (L 20" W 14" H 3/4")



Heater Stand Grill
DW08H40GRILL ●
101.6cm x 36.5cm (L 40" W 14")
DW04H202GRILL ●
50.8cm x 35.6cm (L 20" W 14")



Heater Stand Aluminium Plate w/Groove
DW08H40ALUM ●
101.6 x 35.6 x 1.0cm H (L 40" W 14" H 3/8")
DW04H202ALUM ●
50.8 x 36.5cm (L 20" W 14")

tower



Tower Heater Stand w/Grill
DW08H40KGSS ●
101.6cm x 35.6cm (L 40" W 14")
Chafers sold separately



Tower Heater Stand w/Grill
DW04H202KGSS ●
50.8cm x 35.6cm (L 20" W 14")
Chafers sold separately



Tower Heater Stand w/Aluminium
DW08H40KSS ●
101.6cm x 35.6cm (L 40" W 14")



Tower Heater Stand w/Aluminium
DW04H202KSS ●
50.8cm x 35.6cm (L 20" W 14")



Black Tower Heater Stand w/Grill
DW08H40KGBK ●
101.6cm x 35.6cm (L 40" W 14")



Black Tower Heater Stand w/Grill
DW04H202KGBK ●
50.8cm x 35.6cm (L 20" W 14")



Black Tower Heater Stand w/Aluminium
DW08H40KBK ●
101.6cm x 35.6cm (L 40" W 14")



Black Tower Heater Stand w/Aluminium
DW04H202KBK ●
50.8cm x 35.6cm (L 20" W 14")

millennium



Millennium Heater Stand w/Grill
DW08H40DGSS ●
101.6cm x 35.6cm (L 40" W 14")
Chafers sold separately



Millennium Heater Stand w/Grill
DW04H202DGSS ●
50.8cm x 35.6cm (L 20" W 14")
Chafers sold separately



Millennium Heater Stand w/Aluminium
DW08H40DSS ●
101.6cm x 35.6cm (L 40" W 14")



Millennium Heater Stand w/Aluminium
DW04H202DSS ●
50.8cm x 35.6cm (L 20" W 14")

Pair with Hollowick Chafing Fuels. See pages 80-83 for more information.
HWEZ638 ● Easy Heat 6-3-8 Hour • **HWXTRM424** ● Xtreme Heat 4 Hour • **HWPLUS6** ● Ready Heat Plus 6 Hour
D=Diameter L=Length W=Width H=Height • All Products are Measured at Max Capacity (oz)

● Non-Stock



rustic meets modern

Introducing the first ever HomeStyle cast iron chafer. With the rustic appeal of cast iron, these vessels feature a food and water pan concept that keeps your food from drying out, and work perfectly with either fuel or induction.



HomeStyle Dutch Oven/ Cast Iron Chafer
Red w/ Black Knob (w/o food pan)
DWG4R ● 4.7L (5qt)

Red Cast Iron w/ SS Food Pan
DWG4RF ●



HomeStyle Dutch Oven/ Cast Iron Chafer
Black w/ Black Knob (w/o food pan)
DWG4 ● 4.7L (5qt)

Black Cast Iron w/ SS Food Pan
DWG4F ●



Round Food Pan
DW64RFP ●
30.2cm (L 11⁷/₈" W 11⁷/₈" H 2³/₄")
3.8L (4qt) For 3.8L/4qt Round



Divided Round Food Pan
DW64RFP2 ●
30.5cm (L 12" W 12" H 3")
For 3.8L/4qt Round



Black Porcelain Round Food Pan
DW64RFPORBK ●
30.5cm (L 12" W 12" H 2³/₄")
3.8L (4qt) For 3.8L/4qt Round



White Porcelain Round Food Pan
DW64RFPOR ●
30.5cm (L 12" W 12" H 2³/₄")
3.8L (4qt) For 3.8L/4qt Round

universal cover holder



Satin Universal Cover Holder
DW396CVRHOLD1 ●
27.7cm x 11.4cm H (L 10⁷/₈" H 4¹/₂")



Satin Adapter Clip to
attach cover holder to
Wood Fusion Risers
DWFB14CLIPHOLD1 ●



Tabletop



Attaches to fusion
metal & wood risers



Attaches to 20" & 40"
heater stands

All chafers include a stainless steel food pan.

D=Diameter L=Length W=Width H=Height • All Products are Measured at Max Capacity (oz)

● Non-Stock ● Stocked In European Warehouse



proprietary teflon-coated stainless steel

The lightweight HomeStyle induction chafers are your go-to vessels for fuel or induction heating. Comprised of stainless steel or coated in black, white or red/black Teflon, these chafing dishes include a food pan, and are chip and scratch resistant. More so, the rectangle chafers have a built-in lid holder for convenient buffet service.



food pans



Round Black HomeStyle Chafer
DW06CWG8BK ● (L 17¼" W 15" H 6") 7.5L (2gal)
DW04CWG8BK ● (L 14¼" W 12" H 6¾") 3.8L (4qt)
DW02CWG8BK (L 11½" W 9½" H 5¾") 1.9L (2qt)



Round Black HomeStyle Soup Marmite
DW05CWG8BK ● (L 14¼" W 12" H 7") 5.2L (5½qt)



Rectangle Black HomeStyle Chafer
DW04QCWG8BK ● (L 15½" W 11" H 8") 3.8L (4qt)



Oval Black HomeStyle Chafer
DW02145CWG8BK ● (L 17½" W 11⅞" H 6½") 4.7L (5qt)



Food Pan **DW06RFP4**
 38.7cm (D 15¼" H 3") 7.5L (2gal)
 For 5.7L/2gal Round
DW64RFP ●
 30.2cm (L 11⅞" W 11⅞" H 2¾") 3.8L (4qt) For 3.8L/4qt Round



Divided Food Pan **DW06RFP2**
 38.7cm (D 15¼" H 3") 7.5L (2gal) For 5.7L/2gal Round
DW64RFP2 ●
 30.5cm (L 12" W 12" H 3") 3.8L (4qt) For 3.8L/4qt Round



Half Round Food Pan **DW06RFP22** ●
 38.1cm (L 15" W 6½" H 3") 7.5L (2gal) For 5.7L/2gal Round
 Spacer Bar **DW06RFP22BAR** ●
 For Half Round Food Pan 37.5cm (L 14¾" W ¾" H ¾")



Round Food Pan **DW655RFP** ●
 For 5½qt Round Chafer



Round Red/Black HomeStyle Chafer
DW06CWG8RD2 ● (L 17¼" W 15" H 6") 7.5L (2gal)
DW04CWG8RD2 ● (L 14¼" W 12" H 6¾") 3.8L (4qt)
DW02CWG8RD2 (L 11½" W 9½" H 5¾") 1.9L (2qt)



Round Red/Black HomeStyle Soup Marmite
DW05CWG8RD2 ● (L 14¼" W 12" H 7") 5.2L (5½qt)



Rectangle Red/Black HomeStyle Chafer
DW04QCWG8RD2 ● (L 15½" W 11" H 8") 3.8L (4qt)



Oval Red/Black HomeStyle Chafer
DW02145CWG8RD2 ● (L 17½" W 11⅞" H 6½") 4.7L (5qt)



Oval Food Pan **DW02145NSS** ●
 (D 14½")
 For 5 qt Oval Chafer



White Porcelain Food Pan **DW06RFP4POR**
 38.7cm (D 15¼" H 3") 7.5L (2gal) For 5.7L/2gal Round
DW64RFP4POR ●
 30.5cm (D 12" H 2¾") 3.8L (4qt) For 3.8L/4qt Round



White S Divided Porcelain Food Pan **DW06RFP2SPOR** ●
 38.7cm (D 15¼" H 3") 7.5L (2gal) For 5.7L/2gal Round



Black Porcelain Round Food Pan **DW64RFP4PORBK** ●
 30.5cm (D 12" H 2¾") 3.8L (4qt) For 3.8L/4qt Round



Round White HomeStyle Chafer
DW06CWG8WT ● (L 17¼" W 15" H 6") 7.5L (2gal)
DW04CWG8WT ● (L 14¼" W 12" H 6¾") 3.8L (4qt)
DW02CWG8WT (L 11½" W 9½" H 5¾") 1.9L (2qt)



Round White HomeStyle Soup Marmite
DW05CWG8WT ● (L 14¼" W 12" H 7") 5.2L (5½qt)



Rectangle White HomeStyle Chafer
DW04QCWG8WT ● (L 15½" W 11" H 8") 3.8L (4qt)



Oval HomeStyle Chafer w/ 2 Handles White
DW02145CWG8WT ● (L 17½" W 11⅞" H 6½") 4.7L (5qt)



Round Food Pan **DW62RFP** ●
 (D 9½" H 3")
 For 2 qt Chafer



Shallow Round Food Pan **DW06RFP3** ●
 38.7cm (D 15¼" H 1")
 For 2 gal Round Chafer



Rectangular Food Pan **DW04FP**
 For 4 qt Rectangle Chafer



Round Stainless Steel HomeStyle Chafer
DW06DG8SS ● (L 17¼" W 15" H 6") 7.5L (2gal)
DW04CWG8SS ● (L 14¼" W 12" H 6¾") 3.8L (4qt)



Round HomeStyle Soup Marmite SS
DW05CWG8SS ● (L 14¼" W 12" H 7") 5.2L (5½qt)



Rectangle HomeStyle Chafer SS
DW04QCWG8SS ● (L 15½" W 11" H 8") 3.8L (4qt)



Oval HomeStyle Chafer w/ 2 Handles SS
DW02145DG8SS ● (L 17½" W 11⅞" H 6½") 4.7L (5qt)

All chafers include a stainless steel food pan.

D=Diameter L=Length W=Width H=Height • All Products are Measured at Max Capacity (oz)

● Non-Stock ● Stocked In European Warehouse



Chafer Round Brushed Stainless
7352MW302 9.1L (2gal)
45.7 x 40.0 x 14.0cm H (18" x 15½" x 5½" H)
7352MW301 ● 3.8L (4qts)
38.1 x 31.8 x 12.7cm H (15" x 12½" x 5" H)
7352MW300 1.9L (2qts)
30.5 x 25.4 x 12.7cm H (12" x 10" x 5" H)



Chafer Rectangular Brushed Stainless
7352MW303 3.8L (4qts)
41.9 x 27.3 x 16.5cm H (16½" x 10¾" x 6½" H)



Chafer Round Soup Brushed Stainless
7352MW304 5.2L (5½qts)
38.1 x 31.8 x 13.3cm H (15" x 12½" x 5¼" H)



Chafer Round Antique Brushed Bronze
7353MW302 ● 9.1L (2gal)
45.7 x 40.0 x 14.0cm H (18" x 15½" x 5½" H)
7353MW301 ● 3.8L (4qts)
38.1 x 31.8 x 12.7cm H (15" x 12½" x 5" H)
7353MW300 1.9L (2qts)
30.5 x 25.4 x 12.7cm H (12" x 10" x 5" H)



Chafer Rectangular Antique Brushed Bronze
7353MW303 ● 3.8L (4qts)
41.9 x 27.3 x 16.5cm H (16½" x 10¾" x 6½" H)



Chafer Round Soup Antique Brushed Bronze
7353MW304 ● 5.2L (5½qts)
38.1 x 31.8 x 13.3cm H (15" x 12½" x 5¼" H)

food pans



Food Pan
DW06RFP4
38.7cm (D 15¼" H 3") 7.5L (2gal)
For 5.7L/2gal Round
DW64RFP ●
30.2cm (L 11⅞" W 11⅞" H 2¾")
3.8L (4qt) For 3.8L/4qt Round



Divided Food Pan
DW06RFP2
38.7cm (D 15¼" H 3")
7.5L (2gal) For 5.7L/2gal Round
DW64RFP2 ●
30.5cm (L 12" W 12" H 3")
3.8L (4qt) For 3.8L/4qt Round



Half Round Food Pan
DW06RFP22 ●
38.1cm (L 15" W 6½" H 3")
7.5L (2gal) For 5.7L/2gal Round
Spacer Bar
DW06RFP22BAR ●
For Half Round Food Pan
37.5cm (L 14¾" W ¾" H ¾")



Round Food Pan
DW655RFP ●
For 5½qt Round Chafer



Round Food Pan
DW62RFP ●
(D 9½" H 3")
For 2qt Chafer



White Porcelain Food Pan
DW06RFP4POR
38.7cm (D 15¼" H 3") 7.5L (2gal)
For 5.7L/2gal Round
DW64RFP4POR ●
30.5cm (D 12" H 2¾") 3.8L (4qt)
For 3.8L/4qt Round



White S Divided Porcelain Food Pan
DW06RFP2SPOR ●
38.7cm (D 15¼" H 3") 7.5L (2gal)
For 5.7L/2gal Round



Black Porcelain Round Food Pan
DW64RFP4PORBK ●
30.5cm (D 12" H 2¾")
3.8L (4qt) For 3.8L/4qt Round



Shallow Round Food Pan
DW06RFP3 ●
38.7cm (D 15¼" H 1")
For 2gal Round Chafer



Rectangular Food Pan
DW04FP
For 4qt Rectangle Chafer

All chafers include a stainless steel food pan.

D=Diameter L=Length W=Width H=Height • All Products are Measured at Max Capacity (oz)

● Non-Stock ● Stocked In European Warehouse

servicing food in style

Create an inviting & cosy presentation on your buffet with Homestyle Chafers from Creations. Available in brushed stainless steel and antique bronze finishes, these unique vessels look like cookware you'd use at home, but have the functionality of a high-volume chafing dish at a great price point. Safe for the oven, freezer or on induction, the Homestyle Chafers are also dishwasher safe, making cleanup quick and easy.



pots & casserole dishes with easy maintenance

Folio Cookware & Bakeware bring a whole new level of cooking to the kitchen. These 4-ply ceramic, non-stick pots and casserole dishes are made of lightweight cast aluminium and feature an unbreakable body with excellent cold and heat retention. With the versatility of being used on electric or gas cooktops and oven or induction, the cookware pots offer a unique solution for your buffet presentation, while the bakeware crocks and casseroles are oven safe, providing the perfect vessel for single serve items or sides. Each shape is specifically designed for stacking, and is even dishwasher safe!

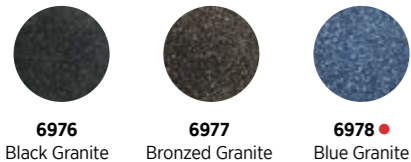

Cooking Pots



Round Induction Buffet Pot Black Granite w/Tempered Glass Lid
6976QU003 561.9cl (190oz)
37.5 x 28 x 11.4cm (14³/₄" x 11³/₄" x 4¹/₂"")
6976QU004 384.5cl (130oz)
37.5 x 28 x 8.25cm (14³/₄" x 11³/₄" x 3¹/₄"")
Round Induction Buffet Pot Black Granite (No Lid)
6976QU003B ● L 14³/₄" W 11³/₄" H 4¹/₂" (1¹/₂gal)
6976QU004B ● L 14³/₄" W 11³/₄" H 3¹/₄" (4qt)



Round Induction Buffet Pot Bronzed Granite w/Tempered Glass Lid
6977QU003 561.9cl (190oz)
37.5 x 28 x 11.4cm (14³/₄" x 11³/₄" x 4¹/₂"")
6977QU004 384.5cl (130oz)
37.5 x 28 x 8.25cm (14³/₄" x 11³/₄" x 3¹/₄"")
Round Induction Buffet Pot Bronzed Granite (No Lid)
6977QU003B ● L 14³/₄" W 11³/₄" H 4¹/₂" (1¹/₂gal)
6977QU004B ● L 14³/₄" W 11³/₄" H 3¹/₄" (4qt)



Round Induction Buffet Pot Blue Granite w/Tempered Glass Lid
6978QU003 561.9cl (190oz)
37.5 x 28 x 11.4cm (14³/₄" x 11³/₄" x 4¹/₂"")
6978QU004 384.5cl (130oz)
37.5 x 28 x 8.25cm (14³/₄" x 11³/₄" x 3¹/₄"")
Round Induction Buffet Pot Blue Granite (No Lid)
6977QU003B ● L 14³/₄" W 11³/₄" H 4¹/₂" (1¹/₂gal)
6977QU004B ● L 14³/₄" W 11³/₄" H 3¹/₄" (4qt)

Replacement Tempered Glass Lid W/Silicone Rim and Knob **6975QU002** 27.9cm (11")

bakeware



Oval Casserole w/Handles
QU012 85.8cl (29oz)
26.7 x 18.7 x 4.5cm (10¹/₂" x 7³/₈" x 1³/₄"")
QU011 165.6cl (56oz)
32.4 x 22.9 x 5.4cm (12³/₄" x 9" x 2¹/₈"")



Round Crock
QU015 ●
L 7¹/₈" W 5⁷/₈" H 2¹/₂" (22oz)
Lid For Round Crock
QU016 ● D 5⁷/₈" H 1¹/₂"



Oval Mini Crock
QU013 43.6cl (14.75oz)
17.8 x 12 x 4.5cm (7" x 4³/₄" x 1³/₄"")



Round Mini Crock
QU009 32.5cl (11oz)
14.6 x 11.4 x 4.5cm (5³/₄" x 4¹/₂" x 1³/₄"")



Round Skillet
QU008 44.4cl (15oz)
26.7 x 16.5 x 3.5cm (10¹/₂" x 6¹/₂" x 1³/₈"")

D=Diameter L=Length W=Width H=Height • All Products are Measured at Max Capacity (oz)

● Non-Stock

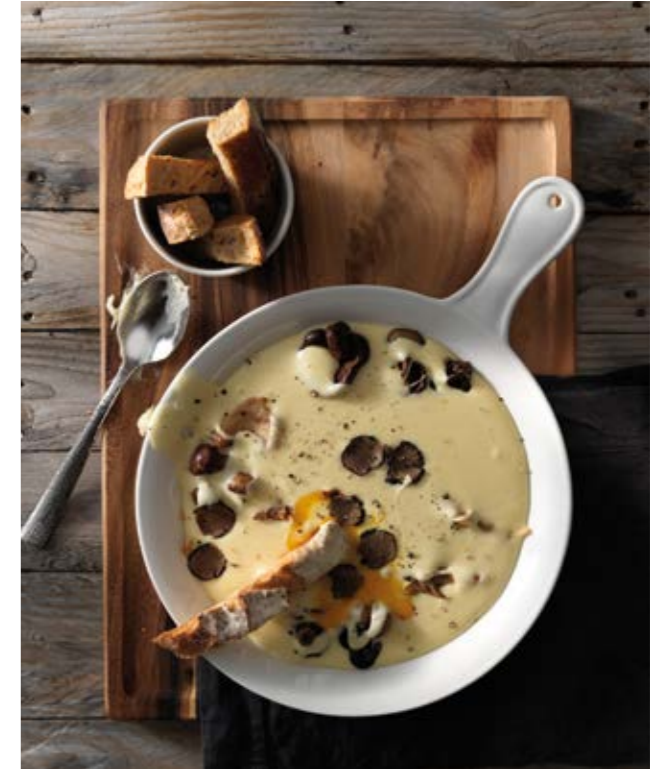

simmer stew serve

Inspired by hand-crafted, simple country wares, the Craft Cookware range offers a variety of presentation opportunities to demonstrate the delights of oven to table cooking.

captivating casual dining

Bring the intoxicating aromas, sights and sounds of your menu to the guest as you captivate their senses with the Simplicity range of cookware.



Oblong Roaster
● **11310331** ●
35.5cm x 30.5cm (14" x 12")
356cl (125oz)
● **11330342** ●
30.5cm x 25.5cm (12" x 10")
227.0cl (80oz)



Square Roaster
● **11300329** ●
25.5cm (10") 185.0cl (65oz)



Oval Sole Dish
● **11330326** ●
28.0cm x 19.0cm (11¹/₈" x 7¹/₂")
148.0cl (52oz)



Oval Baker
● **11300400** ●
15.75cm (6¹/₄") 37.0cl (13oz)



Oval Eared Dish
● **11310321** ●
34.0cm x 19.0cm (13¹/₂" x 7¹/₂")
103.0cl (36¹/₂oz)
● **11330319** ●
24.5cm x 13.5cm (9¹/₂" x 5¹/₂")
36.0cl (12¹/₂oz)
● **11300318** ●
20.0cm x 11.0cm (8" x 4¹/₂")
18.5cl (6¹/₂oz)



Round Eared Dish
● **11310317** ●
21.5cm (8¹/₂") 78.0cl (27¹/₂oz)
● **11300316** ●
19.0cm (7¹/₂") 54.0cl (19oz)
● **11330191** ●
16.5cm (5³/₄") 18.5cl (6¹/₂oz)



Presentation Pan
● **11310866** ●
25.5cm (10") 96.0cl (33¹/₂oz)



Casserole Base
● **1155B828** ● 42.5cl (15oz)
Lid for Casserole
● **11550829** Fits B828

Casserole Base
● **1131B828** ● 42.5cl (15oz)
Lid for Casserole
● **11310829** Fits B828



Oblong Roaster
● **11010331** ●
35.5cm x 30.5cm (14" x 12")
356.0cl (125oz)
● **11010342** ●
30.5cm x 25.5cm (12" x 10")
227.0cl (80oz)



Square Roaster
● **11010329** ●
25.5cm (10") 185.0cl (65oz)



Rectangular Tray
● **11010366** ●
16.5cm x 12.3cm
(6¹/₂" x 4³/₄") 50.0cl (17¹/₂oz)



Casserole
● **11010337** ●
24.4cm x 11.4cm H (9⁵/₈" x 4¹/₂" H)
307.6cl (104oz)
● **11010334** ●
22.2cm x 10.2cm H (8³/₄" x 4" H)
221.8cl (75oz)
Casserole Lid
● **11010338** 24.4cm (9⁵/₈") Fits 0337
● **11010335** 22.2cm (8³/₄") Fits 0334



Oval Sole Dish
● **11010326** ●
28.0cm x 19.0cm (11¹/₈" x 7¹/₂")
148.0cl (52oz)
● **11010327** ●
21.5cm x 14.0cm (8¹/₂" x 5¹/₂")
55.0cl (19oz)



Oval Eared Dish
● **11010321** ●
34.0cm x 19.0cm (13¹/₂" x 7¹/₂")
103.0cl (36¹/₂oz)
● **11010320** ●
30.5cm x 17.0cm (12" x 6¹/₂")
78.0cl (27¹/₂oz)
● **11010319** ●
24.5cm x 13.5cm (9¹/₂" x 5¹/₂")
36.0cl (12¹/₂oz)
● **11010318** ●
20.0cm x 11.0cm (8" x 4¹/₂")
18.5cl (6¹/₂oz)



Round Eared Dish
● **11010317** ●
21.5cm (8¹/₂") 78.0cl (27¹/₂oz)
● **11010316** ●
19.0cm (7¹/₂") 54.0cl (19oz)
● **11010191** ●
16.5cm (6¹/₂") 18.5cl (6¹/₂oz)



Presentation Pan
● **11010866** ●
25.5cm (10") 96.0cl (33¹/₂oz)



Soup Bowl w/Lid
● **11010828** ●
15.9 x 12.4 x 7.6cm H
(6¹/₄" x 4⁷/₈" x 3" H) 42.5cl (15oz)
Soup Bowl Base
● **1101B828** ●
16.5 x 12.4 x 5.7cm H
(6¹/₂" x 4⁷/₈" x 2¹/₄" H) 42.5cl (15oz)
● **11010829** Lid



Oval Baker
● **11010400** ●
15.75cm (6¹/₄") 37.0cl (13oz)
● **11010328** Lipped
15.75cm (6¹/₄") 37.0cl (13oz)



unmatched heat and cold retention

The ceramic food pans from Hall China allow cooked foods to maintain their quality longer. The ceramic body distributes heat and cold more evenly, all the while elevating the look of any buffet presentation. Available in both bright white and white, these food pans have the ability to match your existing tableware.



HALL CHINA *white*



Full Size Food Pan
HL1017POAWHA ●
L 20³/₄" W 12³/₄" H 2¹/₂"
(6¹/₄qt)



Half Size Food Pan
HL1016POAWHA ●
L 12³/₄" W 10³/₈" H 2¹/₂"
(2³/₄qt)



Steam Table Inset
HL8W0AWHA ●
D 10³/₄" H 9" (9qt)
Fits: 10¹/₂" Opening

HALL CHINA *bright white*



Full Size Food Pan
HL1017POABWA ●
L 20³/₄" W 12³/₄" H 2¹/₂"
(6¹/₄qt)



Half Long Food Pan
HL1015POABWA ●
L 20³/₄" W 6³/₈" H 2¹/₂"
(2¹/₄qt)



Half Size Food Pan
HL1016POABWA ●
L 12³/₄" W 10³/₈" H 2¹/₂"
(2³/₄qt)



Chafing Dish
HL8710ABWA ●
L 15¹/₈" H 2³/₄"
(5¹/₄qt)



Heating Lamps & Carving Boards

Ideal for maintaining safe temperatures while chefs prepare and serve food on a buffet, D.W. Haber's collection of heat lamps & carving units will create a standout presentation. With telescoping lamps and elevated boards, your catering expectations will be far exceeded through features such as multiple heat lamp finishes, removable & interchangeable carving surfaces, and recessed edges to keep your surfaces clean.



D.W. Haber
Black Tower
Heater Stand Frame
DW08H40KFRMBK ●
101.6cm x 35.6cm
(L 40" W 14")

Hollowick
Chafing Fuel
HWEZ638 ●
Easy Heat 6-3-8 Hour

D.W. Haber
Maple Carving
Board
DW04H202CB34 ●
50.8cm (L 20" W 14" H 3/4")

D.W. Haber
Heater Stand Aluminium
Plate w/Groove
DW04H202ALUM ●
50.8cm (L 20" W 14")

D.W. Haber
Grey Wash Square Riser
DWFB147WDGW ●
35.6cm x 17.8cm (L W 14" H 7")

D.W. Haber
Round Black HomeStyle Chafer
DW06CWG8BK ●
38.0cm x 9.0cm H (L 14" W 3 1/2" H 6")
7.5L (2gal)

D.W. Haber
Induction Warmer 300 Watt
DWELIN300BE2 ● EU Plug
DWELIN300BE3 UK Plug
34.3cm (L 13 1/2" W 12 1/2" H 4 1/2")
Black Fusion Induction Adapter Ring
DWFB14ADAPBK ●

D.W. Haber
Grey Wash Square Riser
DWFB612WDGW ●
15.2cm x 30.5cm
(L W 6" H 12")

D.W. Haber
Black Glass Square Tile
DWFBGL6BK ●
15.2cm (L W 6" H 3/8")

Rona Dorado
Free Formed Carafe
4810R123 ●
(1 qt) H 11 1/2"
Not available in the EMEA

D.W. Haber
Black Glass Rectangle Tile
DWFBGL2411BK ●
60.9cm x 27.9cm
(L 24" W 11" H 3/8")

Steeelite Performance
Nyx Bowl
12050480 ●
11.0cm (D 4 1/2" H 2") 34.0cl (12oz)

Creations Melamine
Quarry Platter
7192TM304A ●
45.7 x 22.9 x 3.8cm
(L 18" W 9" H 1 1/2")

D.W. Haber
Black Teflon Riser
DW073124116BK ●
61.0 x 28.0 x 15.25cm
(L 24" W 11" H 6")

D.W. Haber
Black Glass Rectangle Tile
DWFBGL2411BK ●
60.9cm x 27.9cm
(L 24" W 11" H 3/8")

Bormioli Rocco
Bodega Mini
4912Q016
22.5cl (7 1/2oz),
H 59mm (2 3/8"), Ø 82mm (3 1/4")
Only available in the UK

Bormioli Rocco
Ypsilon Shot Glass
4945Q426
7.0cl (2 1/4oz)
H 107mm (4 1/4"), Ø 50mm (2")
Only available in the UK

D.W. Haber
Black Teflon Riser
DW073114143BK ●
35.6cm x 7.6cm (L W 14" H 3")

D.W. Haber Grey Wash Teak
Wood Square Tile
DWFBWD1414SGW
35.6cm (L W 14")

Steeelite Performance
Craft Licorice FreeStyle Bowl
12090525 ●
13.0cm (L 5" W 3 3/4" H 2 1/8")
13.6cl (4 2/5oz)

● Stocked in European Warehouse

● Non-Stock



Expanding your hot buffet just got easier with stainless steel heat lamps from Creations. These fixed height lamps are available in both single and double heads, offer brilliant functionality and make a statement with any buffet presentation.



Portable Stainless Steel
Modern Heat Lamp
7351MW310E2 • EU PLUG 220V
7351MW310E3 UK PLUG 220V
Single Head H 22"



Portable Stainless Steel
Modern Heat Lamp
7351MW311E2 • EU PLUG 220V
7351MW311E3 UK PLUG 220V
Double Head H 22"

• Stocked In European Warehouse

All Single Head Lamps: 110v | 250 watt | 2.3 Amp • All Double Head Lamps: 110v | 500 watt | 4.5 Amp • Heat Lamp Bulb: Philips BR125 IR 250w E27 230-250V
All lamps are 16" from table to lamp shade. For 220v Schuko plug add 'E2' to product code, for 220v UK plug add 'E3'. For AUS plug add 'E4'
D=Diameter L=Length W=Width H=Height • All Products are Measured at Max Capacity (oz)



a cut above the rest

Designed to enhance the protein on your buffet service, D.W. Haber's carving boards and stands feature a well-built stainless steel frame and either butcher block, aluminium or granite options for the insert. The versatile 24x18" stands have interchangeable surfaces and feature a drip edge to catch any juices, while the Carving Extreme offers a catch basin to keep surrounding surfaces clean. In either case, your carving station will be elevated from the table, providing an enhanced catering presentation.



Boos Carving Board w/ Wood, Modern Frame
DW724MWSS • 64.1cm x 45.7cm (25¼" x 18")



Carving Extreme w/Butcher Block
DW728R24SS • 76.2cm (30")
 Seafood Extreme
DW728R24NSS • 76.2cm (30")
 Round Maple Butcher Block w/Finger Grips
DW726WDFG25 • 61.0cm x 6.4cm H (24" x 2½" H)
 Must use Telescoping Lamp due to height

All 24" x 18" stands have interchangeable surfaces.

D=Diameter L=Length W=Width H=Height • All Products are Measured at Max Capacity (oz)

• Non-Stock



Beverage & Cereal Dispensers

Beverage & cereal dispensers are essential for venues looking to create the ultimate buffet presentation. Steelite's Collection of 18/10 stainless steel beverage servers provide elegance & style, while the durability is tested and approved for commercial foodservice. The cereal dispensers help minimise waste and maintain cleanliness, creating that lasting impression that professional caterers desire.



Kenny Mack
Carved Cup/Lid Holder
KMK1008ES ●
11.4cm (L W 4½" H 8")
Espresso

D.W. Haber
Grey Wash Teak Wood
Square Tile
DWFBWD66SGW
15.2cm (L W 6")

Creations
3-Tier Stand With Pipe Legs
6525T204
35.6cm x 66.0cm (D 14" H 26")
Ebony

D.W. Haber
Grey Wash Teak
Wood Rectangle Tile
DWFBWD2411SGW
60.9cm x 27.9cm
(L 24" W 11")

Folio Lucia
Stack Soup Cup
4422RF014 ●
D 4¼" H 2 ⅜" (10oz)

Creations Satin Base
Insulated Coffee Pot
7502WL002 ●
L 6" H 8¾" (51oz)
7502WL001 ●
L 5¾" H 7 ⅜" (34oz)

D.W. Haber
Black Teflon Riser
DW073124113BK
61.0 x 28.0 x 7.6cm
(L 24" W 11" H 3")

Folio Lucia
Stack Mug
4422RF023 ●
L 4 ⅝" W 3¼"
H 3¾" (12oz)

D.W. Haber
Black Teflon Riser
DW0731664BK
15.2cm x 10.0cm
(L W 6" H 4")

Folio Lucia
Coupe Plate
4422RF070 ●
D 6"

Bormioli Rocco
Rock Bar Shot Glass
4939Q335
7.0cl (2¼oz)
H 64mm (2½"), Ø 51mm (2")
Only available in the UK

D.W. Haber Tower
Vacuum Insulated Coffee Urns
DW33KTVACSS ●
38.1cm (L 15" W 14½" H 27") 11.4L (3gal)

D.W. Haber
Square Drip Tray w/Drainer
DWDRIP5QSETSS ●
12.7cm (L W 5")

D.W. Haber
Engraved ID Tents
Mirror Stainless Steel
DWIDTENTCSS ●
Coffee 9.5cm (L 3¾" W 2¼")
DWIDTENTDSS ●
Decaf 9.5cm (L 3¾" W 2¼")
DWIDTENTHSS ●
Hot Water 9.5cm (L 3¾" W 2¼")

D.W. Haber Tower
Vacuum Insulated Coffee Urns
Textured Black
DW41KTVACBKSS ●
(L 14" W 14" H 23") 5.7L (1½gal)

Kenny Mack
Carved Beverage
Napkin Holder
KMK1010ES ●
15.2cm (L W 6" H 4")
Espresso

Kenny Mack
Carved Tea/Sugar
Packet Holder
KMK1013ES ●
21.6cm (L 8½" W 9" H 2½")
Espresso



beverage service done right

Serve warm beverages the right way with D.W. Haber's collection of coffee urns. Never worry about warm or burnt coffee with the vacuum insulated urns. The convenient vacuum technology keeps coffee at 165°F for five hours in a 5-gallon urn and over three hours in a 3-gallon urn without preheating. Urns are available with Tempo or Tower leg designs, and can be ordered as either fuel heated or vacuum sealed

tower



Tower Vacuum Insulated Coffee Urns
DW35KTVACSS • 19L (5gal)
 43.2cm (L 17" W 16½" H 31")
DW33KTVACSS • 11.4L (3gal)
 38.1cm (L 15" W 14½" H 27")
DW31KTVACSS • 5.7L (1½gal)
 35.6cm (L 14" W 14" H 23")



Tower Fuel Coffee Urns
DW35KSS • 19L (5gal)
 38.1cm (L 15" W 14½" H 27")
DW33KSS • 11.4L (3gal)
 35.6cm (L 14" W 14" H 23")
DW31KSS • 5.7L (1½gal)
 33.0cm (L 13" W 12" H 18¾")



Tower Vacuum Insulated Coffee Urns
 Textured Black
DW45KTVACBKSS • 19L (5gal)
 43.2cm (L 17" W 16½" H 31")
DW43KTVACBKSS • 11.4L (3gal)
 38.1cm (L 15" W 14½" H 27")
DW41KTVACBKSS • 5.7L (1½gal)
 33.0cm (L 13" W 12" H 18¾")



Tower Fuel Coffee Urns
 Textured White
DW45KWTSS • 19L (5gal)
 38.1cm (L 15" W 14½" H 27")
DW43KWTSS • 11.4L (3gal)
 35.6cm (L 14" W 14" H 23")
DW41KWTSS • 5.7L (1½gal)
 33.0cm (L 13" W 12" H 18¾")

tempo



Tempo Vacuum Insulated Coffee Urns
DW35WTVACSS • 19L (5gal)
 43.2cm (L 17" W 16" H 31")
DW33WTVACSS • 11.4L (3gal)
 38.1cm (L 15" W 14½" H 27")
DW31WTVACSS • 5.7L (1½gal)
 35.6cm (L 14" H 24")



Tempo Fuel Coffee Urns
DW35WSS • 19L (5gal)
 38.1cm (L 15" W 14½" H 27")
DW33WSS • 11.4L (3gal)
 35.6cm (L 14" W 14" H 23")
DW31WSS • 5.7L (1½gal)
 33.0cm (L 13" W 12" H 19")



Tempo Vacuum Insulated Coffee Urns
 Textured White
DW45WTVACWTSS • 19L (5gal)
 43.2cm (L 17" W 16" H 31")
DW43WTVACWTSS • 11.4L (3gal)
 38.1cm (L 15" W 14½" H 27")
DW41WTVACWTSS • 5.7L (1½gal)
 35.6cm (L 14" H 24")



Tempo Fuel Coffee Urns
 Textured Black
DW45WBKSS • 19L (5gal)
 38.1cm (L 15" W 14½" H 27")
DW43WBKSS • 11.4L (3gal)
 35.6cm (L 14" W 14" H 23")
DW41WBKSS • 5.7L (1½gal)
 33.0cm (L 13" W 12" H 19")

Pair with Hollowick Chafing Fuels. See pages 80-83 for more information.

HWZE638 • Easy Heat 6-3-8 Hour • **HWPLUS6** • Ready Heat Plus 6 Hour • **HWREADY6** • Ready Heat 6 Hour • **BUFF624** • Buffet Heat 6 Hour

air pot & cover-up



Zojirushi Air Pot w/
 Double Wall SS Liner
DW02823LZLPOTSS • 3L (3qt)
 22.9cm (L 9" W 7" H 17")



Modern Air Pot Cover-Up
DW02823LZLSS •
 30.5cm (L 12" W 10" H 15½")
 For DW02823LZLPOTSS • (3qt)

Modern Cover-Up w/ Air Pot 2 pc. Set
DW02823LZLSSSET • 27.9cm (11") (3qt)

tents & card holders



Engraved ID Tents Mirror Stainless Steel
DWIDTENTCSS • Coffee 9.5cm (L 3¾" W 2¼")
DWIDTENTDSS • Decaf 9.5cm (L 3¾" W 2¼")
DWIDTENTHSS • Hot Water 9.5cm (L 3¾" W 2¼")
DWIDTENTXSS • Blank 9.5cm (L 3¾" H 2¼")
 Unlimited options for engraving on Tents (ex. Tea, Cream, Milk, etc.)

Freestanding Card Holder
DW07372SS •
 9.8cm (L 3⅞" W 2⅝")

drip trays



Drip Tray w/Drainer
DW30045SET • D 13.4cm (5¼")



Square Drip Tray w/Drainer
DWDRIP50SETSS • L W 12.7cm (5")

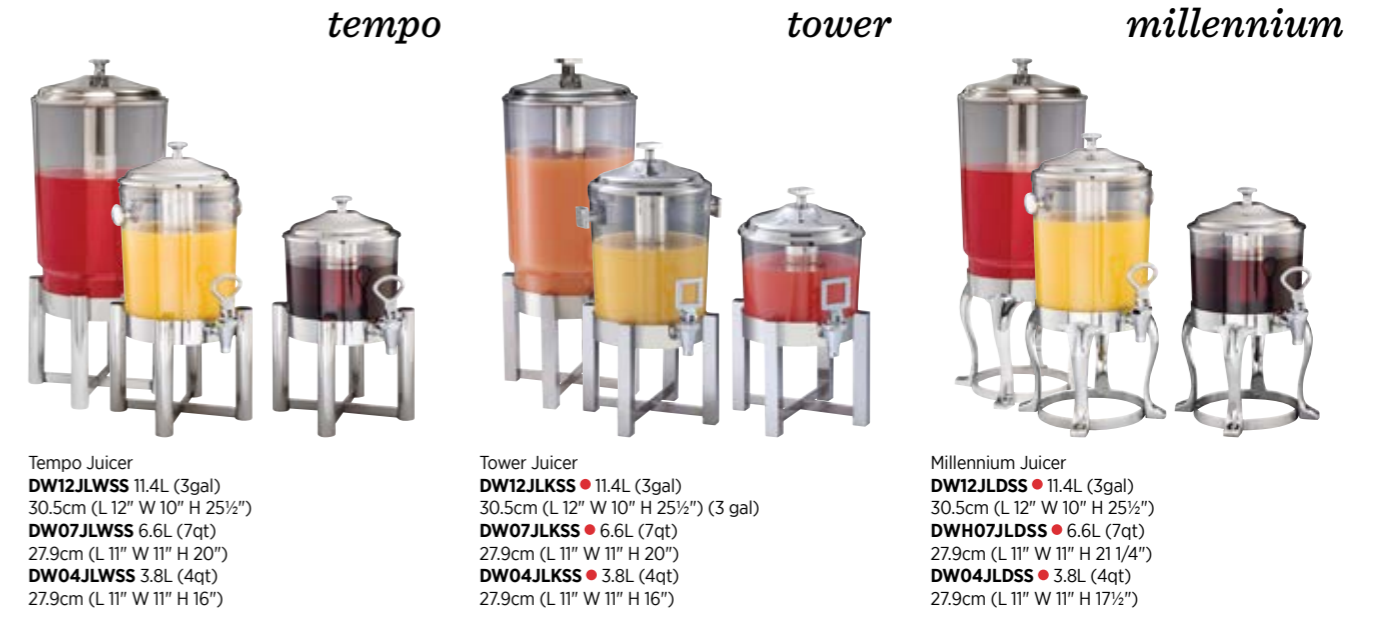

Tempo Juicer
DW12JLWSS 11.4L (3gal)
 30.5cm (L 12" W 10" H 25½")
DW07JLWSS 6.6L (7qt)
 27.9cm (L 11" W 11" H 20")
DW04JLWSS 3.8L (4qt)
 27.9cm (L 11" W 11" H 16")

Tower Juicer
DW12JLKSS 11.4L (3gal)
 30.5cm (L 12" W 10" H 25½") (3 gal)
DW07JLKSS 6.6L (7qt)
 27.9cm (L 11" W 11" H 20")
DW04JLKSS 3.8L (4qt)
 27.9cm (L 11" W 11" H 16")

Millennium Juicer
DW12JLDSS 11.4L (3gal)
 30.5cm (L 12" W 10" H 25½")
DWH07JLDSS 6.6L (7qt)
 27.9cm (L 11" W 11" H 21¼")
DW04JLDSS 3.8L (4qt)
 27.9cm (L 11" W 11" H 17½")

ash grey teak



Juicer w/Ash Grey Teak Wood Base
DW12JLWDAG 11.4L (3gal)
DW07JLWDAG 6.6L (7qt)
DW04JLWDAG 3.8L (4qt)

grey wash teak



Juicer w/Grey Wash Teak Wood Base
DW12JLWDGW 11.4L (3gal)
DW07JLWDGW 6.6L (7qt)
DW04JLWDGW 3.8L (4qt)



natural teak



Juicer w/Natural Teak Wood Base
DW12JLWDT 11.4L (3gal)
DW07JLWDT 6.6L (7qt)
DW04JLWDT 3.8L (4qt)

beverage service done right

Serve chilled beverages the right way with D.W. Haber's collection of juice dispensers. Available in Tempo, Tower, Millennium, and Fusion, the juicers have an ice sleeve in the centre to keep drinks chilled, and a universal base fits three different sized juice vessels.



reducing the spread of germs

Pouring a cup of coffee or juice just got easier with D.W. Haber's Touchless Taps. Simply press a cup against the dispenser to activate the flow and pull away once filled. The Touchless Plus is hands and drip-free, and its wide body targets the side of the glass and not the rim, which ultimately reduces the spread of germs. Made of 18/10 stainless steel, the spouts are resistant to rust and fit any D.W. Haber, and Creations urn or juicer on self-serve stations and buffets.

touchless+



Works on all D.W. Haber & WNK urns & juicers. Single point of contact reduces the spread of germs.

Touchless Plus Tap Handle
DWFCTHDL3DNTSS ●
10.2cm x 14.0cm h (4" x 5½" h)

touchless



Works on all D.W. Haber Fusion Buffet bases. Made of rust resistant 18/10 stainless steel.

Touchless Tap Handle for Fusion Buffet Bases
DWFCTHDL3WNTSS
7.6cm x 12.1cm h (3" x 4¾" h)

refreshing infused beverages

Add some modern flair to your buffet display with an acrylic juice dispenser from Creations. A square body is accompanied by a contemporary stainless steel stand that can be custom powder-coated to appeal to any style. With a central tube that works great as an infuser for flavoured beverages, these juicers will add a fresh look to buffets, lobbies, beverage stations and more.



Juice Dispenser with Stainless Steel Stand
7345MW305 ●
L 10½" W 8½" H 20¾" (8qt)



beautiful display, mess-free service

Ideal for hotels, restaurants, and cafeterias, the Creations Cereal Dispensers feature an elongated tube to beautifully display and serve your favourite cereals. The rubber turn-style mechanism warrants a mess-free service, ensuring that the food won't crumble and helps control food cost. Find the perfect match for the cereal dispensers in the D.W. Haber Insulated Milk Dispensers. Available in Tempo, Tower or Millennium, these dispensers are designed with an ice sleeve that keeps milk at refrigerator temperature for over 5 hours.



DW055MSS ● Dispenser Only (No Stand) 5.2L (5½qt)
DW07JSTNDWDAG Fusion Base Ash Grey Teak
DW07JSTNDWDT ● Fusion Base Natural Teak
DW07JSTNDWDGW Fusion Base Grey Wash Teak

tempo



Tempo Insulated Milk Dispenser w/ Ice Sleeve SS
DW055MLWSS ●
 5.2L (5½qt)
 (L 11" W 11" H 20")
 Keeps milk at refrigerator temperature for over 5 hours
 Dispenser Only (No Stand)
DW055MSS ●

tower



Tower Insulated Milk Dispenser w/ Ice Sleeve SS
DW055MLKSS ●
 5.2L (5½qt)
 (L 11" W 11" H 20")
 Keeps milk at refrigerator temperature for over 5 hours
 Dispenser Only (No Stand)
DW055MSS ●

millennium



Millennium Insulated Milk Dispenser w/ Ice Sleeve SS
DW055MLDSS ●
 5.2L (5½qt)
 (L 11" W 11" H 20")
 Keeps milk at refrigerator temperature for over 5 hours
 Dispenser Only (No Stand)
DW055MSS ●

CREATIONS *cereal dispensers*



Double Cereal Dispenser
7345MW117 ●
 48.3 x 27.9 x 78.7cm H
 (19" x 11" x 31" H)
 11L (11.6qt) Per Cylinder



Single Cereal Dispenser
7345MW116 ●
 31.8 x 24.8 x 78.7cm H
 (12½" x 9¾" x 31" H)
 11L (11.6qt)



chilled to perfection

D.W. Haber beverage & seafood chillers are designed for buffet and tableside service. With both single & double wall options, the wine coolers sit on their own stands to provide easy access for guests as well as a touch of elegance. While the larger beverage chillers and seafood extreme feature built in drains and double wall insulation to prevent sweating. In either case, the stainless steel construction is ultra durable and made to last!



Rectangular Beverage Tub Insulated Double Wall
DWTUB36187 ●
91.4cm x 45.7 x 17.8cm H (36" x 18" x 7" H)



Seafood Extreme
DW728R24NSS ●
D 76.2cm (30")



Punch Bowl w/ Heavy Border SS
DW04052SS ●
47.0cm (18½") 19L (5gal)



Double Wall Beverage Extreme Mirror SS
DW0724TSETSS ● D 61.0cm (24")
Drainer for Beverage Extreme
DW0724TDRN3 ● D 61.0cm x 7.6cm H (24" x 3" H)

- Double wall means no sweat
- 24" diameter (fits 12 wine bottles)
- Includes low drain plate to seat wine bottles
- Optional 3" drainer for shallow beverages
- Capable for use with food or drink presentations
- Available in satin finish and mirror polish

D.W. HABER *wine coolers*



Wine Stand For Two Bottle
Oval Scoop Cooler SS
DW040062VSS
40.6cm x 20.3cm H (16" x 8" H)
Oval Scoop Wine Cooler 2 Bottle
DW040162VSS
26.7cm x 20.3cm (10½" x 8" H)



Wine Stand For Six Bottle
Oval Scoop Cooler SS
DW040066VSS ●
Oval Scoop Wine Cooler 6 Bottle
DW040166VSS ● 41.91cm (16½")



Wine Stand for Double Wine Cooler
DW040042SS ● 30.5cm (12")
Double Wine Cooler, Ogee Border
DW040142SS ●
26.7cm x 24.1cm H (10½" x 9½" H)



Coaster/Underliner
DW30045 ●
D 13.4cm (5¼") 10.2cm (4") Well



Coaster/Underliner
DW30044 ●
D 13.4cm (5¼") 7.6cm (3") Well



The Creations brand includes a wide selection of metal accessories. From traditional round hammering, rice hammering and rim embossments to stainless steel and aluminium wire baskets, the Creations Metal collection has it all. Available in various finishes, shapes and sizes, Creations Metal provides that something extra every buffet or tabletop seeks.



Mirror Finish Water Pitcher
7345MW107 ●
L 8" H 10½"
(3½qts)



Satin Base Insulated Coffee Pot
7502WL002 ●
L 6" H 8¾"
(1¼qt)



Satin Base Insulated Coffee Pot
7502WL001 ●
L 5¾" H 7¾"
(1qt)



Wine Bucket
7600CV036 ●
D 8¼" H 8¾"
Wine Bucket Stand
7600CV037 ●
L 9⅞" W 10⅞" H 28⅞"



Wine Stand
7600CV041 ●
L 10¼" W 9½" H 28"



Wine Bucket Satin
7600CV040 ●
D 7" H 8¼"



CREATIONS *party tub*

Party Tub
7600CV035 ●
L 20¾" W 17¾" H 10¼" (7gal)

ROBERT WELCH *drift* *Robert Welch*



Wine/Champagne Bucket Stand
5977RW003
D 28.0cm H 64.0cm
(D 11" H 25¼")



Wine/Champagne Cooler Large
5977RW020
(L 10⅝" W 16⅞" H 16⅞")



Double Wine/Champagne Bucket
5977RW002
L 28.0 W 21.5 H 23.0cm
(L 11" W 8½" H 9")
Single Wine/Champagne Bucket
5977RW001
L 23.5 W 19.0 H 21.0cm
(L 8⅞" W 7½" H 8⅞")



Double Walled Wine/Champagne Cooler
5977RW013
L 13.6 W 13.4 H 22.4cm
(L 5⅝" W 5¼" H 9")



Carved Tea/Sugar Packet Holder
KMK1013ES ●
21.6 x 22.9 x 6.4cm H
(8½" x 9" x 2½" H) Espresso



Carved Cup/Lid Holder
KMK1008ES ●
11.4cm x 20.3cm (4½" x 8" H)
Espresso



Carved Beverage Napkin Holder
KMK1010ES ●
15.2cm x 10.2cm H (6" x 4" H)
Espresso



Carved Bar Napkin/Straw Holder
KMK1015ES ●
26.0 x 16.5 x 10.2cm H
(10¼" x 6½" x 4" H)
Espresso



Tea/Sugar Packet Holder
KMK1013SH ●
21.6 x 22.9 x 6.4cm H
(8½" x 9" x 2½" H) Shell



Carved Cup/Lid Holder
KMK1008SH ●
11.4cm x 20.3cm (4½" x 8" H)
Shell



Beverage Napkin Holder
KMK1010SH ●
15.2cm x 10.2cm H (6" x 4" H)
Shell



Bar Napkin/Straw Holder
KMK1015SH ●
26.0 x 16.5 x 10.2cm H
(10¼" x 6½" x 4" H)
Shell



Carved Tea/Sugar Packet Holder
KMK1013TG ●
21.6 x 22.9 x 6.4cm H
(8½" x 9" x 2½" H) Tangerine



Carved Cup/Lid Holder
KMK1008TG ●
11.4cm x 20.3cm (4½" x 8" H)
Tangerine

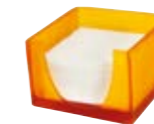

Carved Beverage Napkin Holder
KMK1010TG ●
15.2cm x 10.2cm H (6" x 4" H)
Tangerine



Candle Holder Oval
8.9cm x 8.9cm (3½" x 3½" H)
KMK2409SBICE ● Sky Blue Ice
KMK2409ICESH ● Ice Shell
KMK2409TGP ● Tangerine Pearl
KMK2409TOR ● Tortoise

unique designs for the table & beyond

Accessorise your beverage service display with resin solutions by Kenny Mack. Featuring precisely designed holders for napkins, coffee cups or lids, straws, tea packets and more, these highly durable accessory items are available in 3 colours and provide unique display opportunity for foodservice.



Induction, Chafing Fuel & Burners

Commercial catering is easier with induction solutions from Steelite. The best alternative to open flame, induction technology utilises magnetic currents to heat pots, pans & chafing dishes to provide a safe & efficient cooking experience. Induction gives any foodservice operator the flexibility to host a variety of events, ensuring that food is cooked & served at the right temperature for maximum enjoyment.



cordless warming induction for use anywhere

The D.W. Haber Power Cell is a revolutionary solution for keeping food hot for extended periods of time. The sleek and elegant design makes it a stylish addition to buffets & food stations, and its cordless battery operation allows it to be used anywhere. The Power Cell has a 6-hour recharge time so it can be used for multiple meals per day, and it is a cost-saving solution as it compares to repetitive purchases of chafing fuel. The first of its kind, this induction unit is energy-efficient and operates quietly, ensuring that it won't disturb the ambiance of the setting.



d.w.haber
POWERCELL



Power Cell Cordless Induction Range - Patent-Pending
220V EU & UK Plug
DWELINPCE2E3 ● L 37.1cm x W 33.0cm (L 14⁵/₈" W 13" H 3")
Travel Case
DWELINPCCASE ● L 19" W 15⁷/₈" H 7¹/₈"



Power Cell Cover Up
Ash Grey Teak
DWFB15133WDAG ●
L 42.8 x W 38.1 x H 9.5cm (L 16⁷/₈" W 15" H 3³/₄")



Power Cell Cover Up
Natural Teak
DWFB15133WDT ●
L 42.8 x W 38.1 x H 9.5cm (L 16⁷/₈" W 15" H 3³/₄")



Power Cell Cover Up
Grey Wash Teak
DWFB15133WDGW ●
L 42.8 x W 38.1 x H 9.5cm (L 16⁷/₈" W 15" H 3³/₄")



Induction Warmer 300 Watt
34.3 x 31.8 x 11.4cm H
(13½" x 12½" x 4½" H)
300w/220V
Adapter required with induction
when using with a riser
DWELIN300BE2 ● EU Plug
DWELIN300BE3 UK Plug



Induction Range 1800 Watt
34.3 x 31.8 x 11.4cm H
(13½" x 12½" x 4½" H)
1800w/220V
Adapter required with induction
when using with a riser
DWELIN1800BE2 ● EU Plug
DWELIN1800BE3 UK Plug

butane cover up



Modern Butane Cover-Up w/Grill
DW0281MGSS ●



maximum heat performance

The proper placement of any chafing fuel source is critically important to have maximum heat performance. With Hollowick Easy Heat® Chafing Fuels, the wick is adjustable to accommodate different temperature levels and the can stays cool for easy handling. Simply adjust the wick to change the heat output between standard, low and high, then place on the fuel holder or table beneath to properly heat the chafing dish.

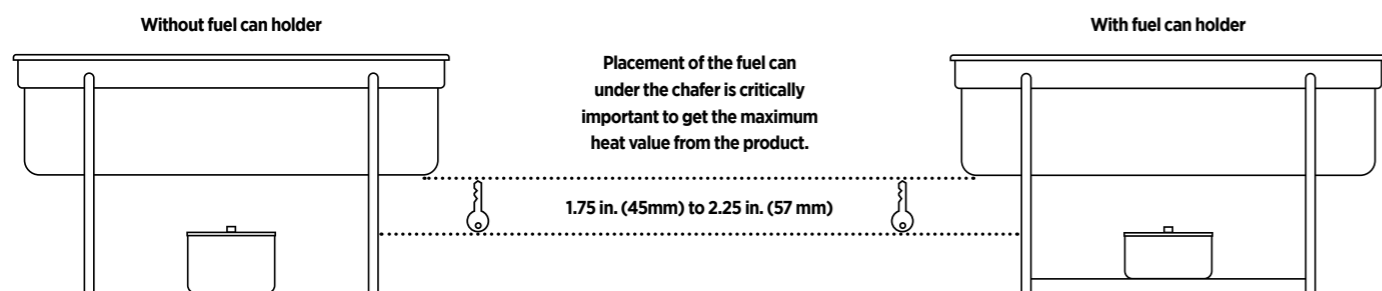

consistent flame & adjustable heat

Easy Heat® liquid chafing fuels are the go-to choice for buffet service. With a consistent flame for even heat, the wicks are located outside the canister keeping the flame position the same as it burns and the can cool so servers can easily handle during service. The wicks are also easily adjustable to provide different levels of heat to suit operator needs. Comprised of Diethylene Glycol, Hollowick's Easy Heat® fuels are non-flammable and enclosed in a sealed canister to prevent spill accidents and reuse on separate occasions.

| | | |
|---|---|---|
|  <p>HWEZ638 • Case: 24 HWEZ6386PK • Case: 6 Burn Time: 6-3- or 8 hours</p> |  <p>HWEZ425 • Burn Time: 4-2- or 5 hours Case: 24</p> |  <p>HWEZ213 • Burn Time: 2-1- or 3 hours Case: 48</p> |
|---|---|---|

• Non-stock item. Due to shipping restrictions, all non-stock liquid candles and fuel-based items can only be purchased on a minimum order quantity basis and will be shipped directly from Hollowick, USA.
 D=Diameter L=Length W=Width H=Height • All Products are Measured at Max Capacity (oz)



xtreme heat[®]

larger, hotter flame

Xtreme Heat[®] by Hollowick burns hotter than gel fuels with its specially designed wick that provides larger and hotter flame. Featuring a pop top, Xtreme Heat[®] burns clean and contains a safe non-flammable liquid.



HWXTRM424 ●
Burn Time: 4 hours
Case: 24



buffet heat

clean burning, no odour

Buffet Heat liquid chafing fuel offers medium heat in 6, 4 and 2-hour can sizes. Containing a convenient resealable lid to allow use on separate occasions, Buffet Heat is ideal for a chafer and other food warming needs.



HWBUFF624 ●
Burn Time: 6 hours
Case: 24



HWBUFF4 ●
Burn Time: 4 hours
Case: 24



HWBUFF2 ●
Burn Time: 2 hours
Case: 24



ready heat

easy-off screw top

Keep food warm with Hollowick Ready Heat chafing fuel. Offering medium heat in 3 can sizes, this non flammable liquid fuel can is resealable and always cool to the touch, making service convenient & simple.



HWREADY6 ●
Burn Time: 6 hours
Case: 24



HWREADY4 ●
Burn Time: 4 hours
Case: 24



HWREADY2 ●
Burn Time: 2 hours
Case: 48



ready heat plus

can stays cool during service

Ready Heat Plus is a superior chafing fuel that burns as hot as gel, and provides an easy-off screw top to easily reseal and reuse. This chafing fuel is made of safe, non flammable liquid and burns clean with no odour.



HWPLUS6 ●
Burn Time: 6 hours
Case: 24



HWPLUS4 ●
Burn Time: 4 hours
Case: 24



HWPLUS2 ●
Burn Time: 2 hours
Case: 72

value heat

the economical choice for food warming

Value Heat from Hollowick provides a safe, value conscious solution for food warming. Its non-flammable liquid burns clean without odour and comes in three can sizes: 6, 4 and 2 hour burn time.



HWVALUE6 ●
Burn Time: 6 hours
Case: 24



HWVALUE4 ●
Burn Time: 4 hours
Case: 24



HWVALUE2 ●
Burn Time: 2 hours
Case: 48

hot 5

easy to use, value priced

Hollowick Hot 5 is a specifically designed for easy use; simply remove the cap and light. Intended for five hours of burn time, Hot 5's fuel can is safely sealed, therefore the can is safe & cool to handle at any point.



HWHOT524 ●
Burn Time: 5 hours
Case: 24



● Non-stock item. Due to shipping restrictions, all non-stock liquid candles and fuel-based items can only be purchased on a minimum order quantity basis and will be shipped directly from Hollowick, USA.
D=Diameter L=Length W=Width H=Height • All Products are Measured at Max Capacity (oz)



Custom Powder Coating

Create a unique buffet presentation with custom powder coat options on our stainless steel buffetware. Available in a textured or hammered finish and a wide variety of colours, high temperature powder coat is durable, dishwasher safe, hides fingerprints and creates a new fresh look on any buffet.



custom powder coating

Powder Coating is a popular option for buffet products in the commercial foodservice industry. It's a type of coating that is applied as a free-flowing, dry powder to the surface of a product. Powder coating creates a hard, durable finish that is resistant to scratches, chipping and fading, making it ideal for high volume use and a demanding buffet service environment. It also enables operators to tailor the colour & finish of chafing dishes, urns, or heat lamps to match their brand or decór. Available in a vast selection of colours or finishes, create a professional and cohesive look on any buffet service with custom powder coating. Contact us today to learn more!



endless colour options



add a textured finish



two tone options available



Tempo Fuel Coffee Urns
Textured White
DW45WWTSS ● 19L (5gal)
DW43WWTSS ● 11.4L (3gal)
DW41WWTSS ● 5.7L (1½gal)

Tempo Vacuum Insulated Coffee Urns
Textured Black
DW45WTVACBKSS ● 19L (5gal)
DW43WTVACBKSS ● 11.4L (3gal)
DW41WTVACBKSS ● 5.7L (1½gal)

For further details and a full offering of available options contact your customer service rep.
D=Diameter L=Length W=Width H=Height • All Products are Measured at Max Capacity (oz)

● Non-Stock



Visual Display

Creating a visually appealing buffet display is crucial in the foodservice industry, as it is the first impression that guests will have of the food & service. At Steelite, we offer professional caterers the right tools to create the perfect presentation every time. From rustic teak wood to modern, black teflon risers and acrylic bakery boxes to gastronomic platters, the possibilities are endless to create a well-crafted visual display.

sophistication for any setting

The Fusion Buffet System is a unique and versatile solution for your foodservice presentation. With multi-sized risers, juicers, and baskets, you can mix and match your display with the numerous wood & metal finishes available. Designed from reclaimed wood, the teak products are environmentally friendly and cost effective, while its natural properties make it resistant to heat, light and moisture. Resin, tempered glass or teak wood tiles can also be used to add new heights, while the 14" risers can be outfitted with universal inserts that make cooking and heating easier.

finish options available

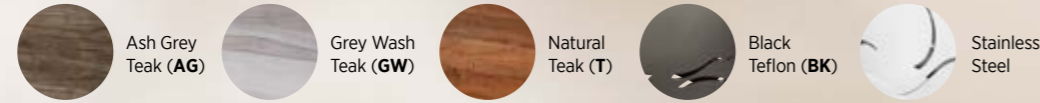

Folio Azores
Caldeira Plate
6213FA001
D 25.5cm (10")
Not available in the UK

D.W. Haber
Black Tower Heater Stand w/Aluminium Plate
DW04H202KBK ●
50.8cm (L 20" W 14")

D.W. Haber
Black Card Holder for Metal Fusion
DW07372BK ●
9.8cm (L 3 7/8" W 2 3/8")

Folio Azores
Caldeira Plate
6213FA003
D 15.25cm (6")
Not available in the UK

D.W. Haber
Serving Tong
DW396ST9
22.9cm (9 1/4")

D.W. Haber
Cover Holder
DW396CVRHOLD1 ●
Satin SS Adapter Clip
DWFB14CLIPHOLD1 ●

D.W. Haber
Black Hanging Card
Holder for Wood Risers
DW07373HK2BK ●
9.8cm (L 3 7/8" W 2 3/8")

D.W. Haber
Ash Grey Fusion Buffet Riser Gastronom
DWFB20127WDAG 58.4 x 38.1 x 18.4cm (L 23" W 15" H 7 1/4")

D.W. Haber Fusion Grill for Gastronom Riser Stainless Steel
DWFB20GRILL ● (L 21 1/4" W 13 1/4")
Fusion Fuel Shelf for Gastronom Riser Stainless Steel
DWFB20SHELF ● (L 14 1/2" W 4")
Fuel Holder **DW01001** ●

Creations Chafer Round Brushed Stainless
7352MW301 ● 3.8L (4qts) 38.1 x 31.8 x 12.7cm (L 15" W 12 1/2" H 5")
7352MW300 1.9L (2qts) 30.5 x 25.4 x 12.7cm (L 12" W 10" H 5")

D.W. Haber Ash Grey 3 Piece Riser Set
DWRISERS3WDAG
58.4cm (L 23" W 6") in 3 Heights: 1 1/2", 3 1/2", 5 1/2"

Folio Oval Mini Crock **6977QU013**
17.8 x 12 x 4.5cm (L 7" x W 4 3/4" x H 1 3/4") 43.6cl (14.75oz)

Folio Bryce **5731SX001** ● Teaspoon (6 1/4")

D.W. Haber
Ash Grey Square Riser
DWFB612WDAG
15.2cm x 30.5cm (L W 6" H 12")

D.W. Haber
Black Glass Square Tile
DWFBGL12BK ●
30.5cm (L W 12" H 3 1/8")

Rona Stellar Shot Glass
4802R261 ● (1 1/4oz)

D.W. Haber Black Card Holder
DW07372BK ●
9.8cm (L 3 7/8" W 2 3/8")

D.W. Haber
Ash Grey Square Riser
DWFB66WDAG
15.2cm x 15.2cm (L W 6" H 6")

D.W. Haber
Black Glass Square Tile
DWFBGL6BK ●
15.2cm (L W 6" H 3 1/8")

D.W. Haber
Juicer w/ Ash Grey
Teak Wood Base
DW12JLWDAG 11.4L (12qt)

D.W. Haber
Drip Tray w/Drainer
DW30045SET ●
D 13.4cm (5 1/4")

Folio
Jewel Rocks
6460BW030 ● (12 1/2oz)

D.W. Haber
Juicer w/ Ash Grey
Teak Wood Base
DW07JLWDAG 6.6L (7qt)



Steelite Performance
Vesuvius Coupe Plate
12010567 ● D 20.25cm (8")

D.W. Haber
Natural Teak Square Riser
DWFB66WDT ●
15.2cm x 15.2cm (L W 6" H 6")

D.W. Haber
Black Glass Square Tile
DWFBGL6BK ●
15.2cm (L W 6" H 3/8")

D.W. Haber
DW396ST9
Serving Tong 22.9cm (9")

Steelite Performance
Ink Nomad Blue Coupe Plate
17620568
D 15.25cm (6")

Folio Alpha-Ceram
Serving Bowl
6959E6132 ●
(D 15" H 4") (5qt)

D.W. Haber
Black Glass Rectangle Tile
DWFBGL241BK ●
60.9cm x 27.9cm
(L 24" W 11" H 3/8")

Steelite Performance
Aurora Revolution Tulip Bowl
17800541 ●
17.5cm (D 7" H 3 1/4") 106.0cl (37.3oz)

D.W. Haber
Natural Teak Square Riser
DWFB612WDT ●
15.2cm x 30.5cm (L W 6" H 12")

D.W. Haber
Black Glass Square Tile
DWFBGL6BK ●
15.2cm (L W 6" H 3/8")

Steelite Performance
Revolution Essence Bowl
17770597
16.5cm (D 6 1/2" H 2 3/8")
58.5cl (20.6oz)

Steelite Performance
Aurora Revolution Bowl
17800481 ●
D 13.5cm (5 1/4") 45.5cl (16oz)

D.W. Haber
Black Glass Rectangle Tile
DWFBGL2407BK ●
60.9cm x 17.8cm (L 24" W 7" H 3/8")
DWFBGL241BK ●
60.9cm x 27.9cm (L 24" W 11" H 3/8")

D.W. Haber
Natural Teak Square Riser
DWFB612WDT ●
15.2cm x 30.5cm (L W 6" H 12")

D.W. Haber
Black Glass Square Tile
DWFBGL6BK ●
15.2cm (L W 6" H 3/8")

D.W. Haber
Stackable Sauceboat
DW8011SS ● 32.5cl (11oz)
24.1cm (L 9 1/2" W 4" H 3 1/4")

D.W. Haber
Black Glass Rectangle Tile
DWFBGL241BK ●
60.9cm x 27.9cm (L 24" W 11" H 3/8")

Folio Alpha-Ceram
Platter Rectangle
6959E6135 ●
(L 18 1/2" W 10 1/2" H 1 1/4")

Folio Alpha-Ceram
Crock
6959E6133 ●
(D 6" H 7") (2qt)
6959E6137 ●
(D 5" H 5 1/2") (1qt)

D.W. Haber
Natural Teak Square Riser
DWFB66WDT ●
15.2cm x 15.2cm
(L W 6" H 6")

D.W. Haber
Black Glass Square Tile
DWFBGL6BK ●
15.2cm (L W 6" H 3/8")

● Stocked in European Warehouse

● Non-Stock



Steelite Performance
Urban Coupe Plate
12080567
D 20.25cm (8")

D.W. Haber Rectangle Black HomeStyle Chafer
DW04QCWG8BK
(L 13¼" W 11½") 3.8L (4qt)

D.W. Haber
Gastronorm Buffet Riser
DWFB20127WDGW
58.4 x 38.1 x 18.4cm (L 23" W 15" H 7¼")

D.W. Haber
Fusion Grill for Gastronorm Riser
Stainless Steel
DWFB20GRILL (L 21¼" W 13¼")

D.W. Haber
Fusion Fuel Shelf for Gastronorm Riser
Stainless Steel
DWFB20SHELF (L 14½" W 4")
Fuel Holder
DW01001

D.W. Haber
Black Hanging Card Holder
for Wood Risers
DW07373HK2BK
9.8cm (L 3⅞" W 2⅜")

D.W. Haber
Hammered Serving Tong
DW396ST9
22.9cm (9¼")

Steelite Performance
Craft Licorice Coupe Plate
12090568 D 15.25cm (6")

Creations
Royce Teapot w/Lid
7347MW148
(17oz)

D.W. Haber Square Riser
DWFB612WDGW
15.2cm x 30.5cm (L W 6" H 12")

D.W. Haber Black Glass
Square Tile
DWFBGL6BK
15.2cm (L W 6" H ⅜")

D.W. Haber
Black Card Holder
DW07372BK
9.8cm (L 3⅞" W 2⅜")

Kenny Mack
Slant Bowl Shell
KMK1025SH
20.3cm (D 8" H 6") (1qt)

D.W. Haber
Square Riser
DWFB66WDGW
15.2cm x 15.2cm
(L W 6" H 6")

D.W. Haber
Black Glass Square Tile
DWFBGL6BK
15.2cm (L W 6" H ⅜")

Steelite Performance
Taste Bowl
11070633 56.75cl (20oz)
12.0cm (D 4¾" H 3")

D.W. Haber
3 Piece Riser Set
DWRISERS3WDGW
58.4cm (L 23" W 6")
in 3 Heights: 1½", 3½", 5½"

D.W. Haber
Tower Round Chafer Full Glass Lid
DW06KH7SS 7.5L (2gal)
44.5cm (L 17½" W 18" H 12")

D.W. Haber
Divided Round Food Pan
DW06RFP2
38.7cm (D 15½" H 3")
7.5L (2gal)

D.W. Haber Fuel Holder **DW01001**

D.W. Haber
Black Card Holder
DW07372BK
9.8cm (L 3⅞" W 2⅜")

Steelite Performance
Craft Licorice Coupe Plate
12090568
D 15.25cm (6")

D.W. Haber
Gastronorm Buffet Riser
DWFB20127WDGW
58.4 x 38.1 x 18.4cm (L 23" W 15" H 7¼")
(Fits EL590, EL591)

D.W. Haber
Bakery Split Cover
7345MW150
54.6cm x 34.9cm (L 21½" W 13¾")

D.W. Haber
Ice Bin for Gastronorm Risers
DW08WP6PL
(L 20⅞" W 12¾" H 6")

Bormioli Rocco
Emilia Swing Top Bottle
49137Q472 50.0cl (17oz)
H 210mm (8¼"), Ø 74mm (3")
Only available in the UK

Stocked in European Warehouse

Non-Stock



D.W. Haber
Gastronorm Buffet Riser
DWFB20127WDT ●
58.4 x 38.1 x 18.4cm (L 23" W 15" H 7¼")
(Fits EL590, EL591)

D.W. Haber Bakery Split Cover
7345MW150 ●
54.6cm x 34.9cm (L 21½" W 13¾")

D.W. Haber Ice Bin for Gastronorm Risers
DW08WP6PL ●
(L 20⅞" W 12¾" H 6")

Bormioli Rocco
Ypsilon Carafe
4945Q939 114.0cl (38½oz)
H 215mm (8½"), Ø 115mm (4½")
Only available in the UK

D.W. Haber Stainless Steel Hanging Card Holder
for Fusion Wood Risers
DW07373HK2SS
9.8cm (L 3⅞" W 2⅜")



D.W. Haber
Carrera Resin Square Tile
DWKFB1212CAR ● 30.5cm (L W 12" H 3⅞")

D.W. Haber Black Universal Shelf Holder for
Teak Fusion Risers
DWFBUSHT4 ●

Folio Lucia
Coupe Plate
4422RF070 ● (D 6")



D.W. Haber
Gastronorm Buffet Riser
DWFB20127WDT ●
58.4 x 38.1 x 18.4cm (L 23" W 15" H 7¼")

D.W. Haber
Ice Cell
DWFB20ICESET ●
Set Includes 1 Tray, 2 Cooling Blocks and 2 Buffer Pouches
Gastronorm Platter Sold Separately
DWFBGN1 ●
Gastronorm White Rectangle Platter 1/1

D.W. Haber
Stainless Steel Hanging Card Holder for Fusion Wood Risers
DW07373HK2SS
9.8cm (L 3⅞" W 2⅜")



D.W. Haber
Angled Square Bread Basket
DWFBWDBASK1ST ●
35.6cm (L W 14")

D.W. Haber
Stainless Steel Riser
DW073114145SS ●
35.6cm x 12.75cm (L W 14" H 5")



Creations
Double Cereal Dispenser
7345MW117 ●
48.3 x 27.9 x 78.7cm (L 19" W 11" H 31")
11L (11.6 qt Per Cylinder)

Folio Lucia
Stack Soup Cup
4422RF014 ●
(D 4¼" H 2⅜") (10oz)

D.W. Haber Stainless Steel
Freestanding Card Holder
DW07372SS ●
9.8cm (L 3⅞" W 2⅜")



D.W. Haber
Insulated Milk Dispenser w/ Ice Sleeve
DW055MSS ● (5½qt)

D.W. Haber
Fusion Base Natural Teak
DW07JSTNDWDT ●

D.W. Haber
Square Drip Tray w/Drainer
DWDRI5QSETSS ● 12.7cm (L W 5")

Folio Lucia
Stack Soup Cup
4422RF014 ●
(D 4¼" H 2⅜") (10oz)



D.W. Haber
Black Tower
Heater Stand Frame
DW08H40KFRMBK ●
101.6cm x 35.6cm
(L 40" W 14")

D.W. Haber
Maple Carving
Board
DW04H202CB34 ●
50.8cm (L 20" W 14" H ¾")

D.W. Haber
Heater Stand Aluminium
Plate w/Groove
DW04H202ALUM ●
50.8cm (L 20" W 14")

D.W. Haber
Grey Wash Square Riser
DWFB147WDGW
35.6cm x 17.8cm (L W 14" H 7")

D.W. Haber
Round Black HomeStyle Chafer
DW06CWG8BK ●
7.5L (2gal) (L 14" W 3½" H 6")

D.W. Haber
Induction Warmer 300 Watt
DWELIN300BE2 ● EU Plug
DWELIN300BE3 ● UK Plug
34.3cm (L 13½" W 12½" H 4½")
Black Fusion Induction Adapter Ring
DWFB14ADAPBK ●
35.6cm (14")

D.W. Haber
Grey Wash Square Riser
DWFB612WDGW
15.2cm x 30.5cm
(L W 6" H 12")

D.W. Haber
Black Glass Square Tile
DWFBGL6BK ●
15.2cm (L W 6" H ¾")

D.W. Haber
Black Glass Rectangle Tile
DWFBGL241BK ●
60.9cm x 27.9cm
(L 24" W 11" H ¾")

Steelite Performance
Nyx Bowl
12050480 ●
11.0cm (D 4½" H 2") 34.0cl (12oz)

Creations Melamine
Quarry Platter
7192TM304A ●
45.7 x 22.9 x 3.8cm
(L 18" W 9" H 1½")

D.W. Haber
Black Teflon Riser
DW073124116BK
61.0 x 28.0 x 15.25cm
(L 24" W 11" H 6")

D.W. Haber
Black Glass Rectangle Tile
DWFBGL241BK ●
60.9cm x 27.9cm
(L 24" W 11" H ¾")

Bormioli Rocco
Bodega Mini
4912Q016 22.5cl (7½oz)
H 59mm (2¼"), Ø 82mm (3¼")
Only available in the UK

Bormioli Rocco
Ypsilon Shot Glass
4945Q426 7.0cl (2¼oz)
H 107mm (4¼"), Ø 50mm (2")
Only available in the UK

D.W. Haber
Black Teflon Riser
DW073114143BK ●
35.6cm x 7.6cm
(L W 14" H 3")

D.W. Haber Grey Wash Teak
Wood Square Tile
DWFBWD1414SGW
35.6cm (L W 14")

Steelite Performance
Craft Licorice FreeStyle Bowl
12090525 ●
13.0cm (L 5" W 3¾" H 2⅛")
13.6cl (4⅔oz)

● Stocked in European Warehouse

● Non-Stock



Folio Azores
Costa Plate
6210FA002
D 20.25cm (8 1/2")
Not available in the UK

D.W. Haber Round Black HomeStyle Chafer
DW06CWG8BK ●
7.5L (2gal) (L 14" W 3 1/2" H 6")

D.W. Haber Square Riser Natural Teak
DWFB147WDT ●
35.6cm x 17.8cm (L W 14" H 7")

D.W. Haber Square Grill
DWFB14GRILL ● L W 35.6cm (14")

D.W. Haber Fuel Holder **DW01001** ●

D.W. Haber Black Hanging Card Holder
DW07373HK2BK ● 9.8cm (L 3 7/8" W 2 3/8")

D.W. Haber Cover Holder
DW396CVRHOLD1 ● 27.7cm x 11.4cm (11" x 4 1/2")
Satin SS Adapter Clip
DWFB14CLIPHOLD1 ●

D.W. Haber
Black Glass Square Tile
DWFBGL12BK ●
30.5cm (L W 12" H 3/8")

Folio Bryce
Long Serving Spoon
5731SX062 27.3cm (10 3/4")

D.W. Haber
Spoon Rest
DW394SR 13.4cm (5 1/4")

D.W. Haber
Black Shelf Holder
DWFBUSHT4 ●

D.W. Haber
Round Black HomeStyle Chafer
DW04CWG8BK ●
30.0cm x 9.0cm (L 11 1/4" W 3 1/2" H 6")
3.8L (4qt)

D.W. Haber Induction Range
1800 Watt
34.3 x 31.8 x 11.4cm H (L 13 1/2" W 12 1/2" H 4 1/2")
DWELIN1800BE2 ● EU Plug
DWELIN1800BE3 UK Plug

D.W. Haber Black Fusion
Induction Adapter Ring
DWFB14ADAPBK ● 35.6cm (14")
(Required for Induction when
used with the 14" teak risers)

D.W. Haber Black Hanging Card Holder
DW07373HK2BK ●
9.8cm (L 3 7/8" W 2 3/8")

D.W. Haber Tower Round Chafer Full Glass Lid
DW06KH7SS ●
44.5cm (L 17 1/2" W 18" H 12") 7.5L (2gal)

D.W. Haber Divided Round Food Pan
DW06RFP2
38.7cm (D 15 1/4" H 3") 7.5L (2gal)

Folio Bryce Long Serving Spoon
5731SX062 27.3cm (10 3/4")

Folio Bryce Large Tong
5731SX073 25.4cm (10")

D.W. Haber Spoon Rest
DW394SR 13.4cm (5 1/4")

D.W. Haber Fuel Holder **DW01001** ●

D.W. Haber Rectangle Tile Natural Teak
DWFBWD2411ST ●
60.9cm x 27.9cm (L 24" W 11")

D.W. Haber Black Card Holder
DW07372BK ● 9.8cm (L 3 7/8" W 2 3/8")

Steelite Performance
Revolution Coupe Plate
17760568 D 15.25cm (6")

D.W. Haber Serving Tong
DW396ST9
22.9cm (9")

Kenny Mack
Jagged Edge Bowl
KMK2083ES ●
33.0cm (D 13" H 4 1/2")
Espresso

Ypsilon Carafe
4945Q412 107.5cl (36 1/4oz)
H 255mm (10"), Ø 102mm (4")
Only available in the UK

Creations Melamine
Slate Rectangle Gastronom Platter
68A415EL593 ●
325mm x 265mm (L 12 3/4" W 10 1/2")
68A415EL595 ●
325mm x 176mm (L 12 3/4" W 7")

● Stocked in European Warehouse

● Non-Stock



D.W. Haber Round Stainless Steel HomeStyle Chafer
DW04CWG8SS ● 3.8L (4qt)
 30.0cm x 9.0cm H
 (11¹/₈" x 3¹/₂" H)

D.W. Haber White Round Porcelain Food Pan
DW64RFPPOR ●
 30.5cm (12") 3.8L (4qt)
 D.W. Haber Square Riser
DWFB145WDAG
 35.6cm x 12.7cm (L W 14" H 5")

D.W. Haber Black Card Holder
DW07373HK2BK ●
 9.8cm (L 3⁷/₈" W 2³/₈")

D.W. Haber Square Grill
DWFB14GRILL ●
 L W 35.6cm (14")

D.W. Haber Cover Holder
DW396CVRHOLD1 ●
 Satin SS Adapter Clip
DWFB14CLIPHOLD1 ●
 D.W. Haber Black Shelf Holder
DWFBUSHT4 ●

D.W. Haber Square Riser
DWFB66WDAG
 15.2cm x 15.2cm
 (L W 6" H 6")

D.W. Haber Black Glass Tile
DWFBGL12BK ●
 30.5cm
 (L W 12" H 3³/₈")

D.W. Haber Black Glass Tile
DWFBGL6BK ●
 15.2cm
 (L W 6" H 3³/₈")

D.W. Haber Spoon Rest
DW394SR
 13.4cm (5¹/₄")

Folio Bryce Small Tong
5731SX074
 17.8cm (7")

D.W. Haber Round SS HomeStyle Chafer
DW04CWG8SS ● 3.8L (4qt)
 30.0cm x 9.0cm H (11¹/₈" x 3¹/₂" H)

D.W. Haber White Round Porcelain Food Pan
DW64RFPPOR ● 30.5cm (12") 3.8L (4qt)

D.W. Haber Fusion Buffet Riser Gastronorm
DWFB20127WDAG
 58.4 x 38.1 x 18.4cm (L 23" W 15" H 7¹/₄")

D.W. Haber Fusion SS Grill for Gastronorm Riser
DWFB20GRILL ●
 (L 21¹/₄" W 13¹/₄")

Steelite Performance Craft White FreeStyle Bowl
11550523 ●
 28.0cm (L 11" W 9¹/₂")
 87.25cl (30.7oz)

Varick Fulton Vintage Copper
5735 18/0

Steelite Performance Craft White FreeStyle Bowl
11550525 ●
 13.0cm (5") 13.6cl (4¹/₂oz)

Steelite Performance Craft White Rectangle Tray
11550556 ●
 33.0cm x 19.0cm (L 13" W 7¹/₂")

D.W. Haber Stackable Bakery Box with Acrylic Drawer
DWFBWDBDAG
 (L 14" W 8¹/₂" H 8")

D.W. Haber Black Glass Rectangle Tile
DWFBGL2411BK ●
 60.9cm x 27.9cm (L 24" W 11" H 3³/₈")
DWFBGL2407BK ●
 60.9cm x 17.8cm L 24" W 7" H 3³/₈"

D.W. Haber Bread Tray w/Applied Border
DW1609 ●
 22.9cm (L 9")

D.W. Haber Square Riser
DWFB147WDAG
 35.6cm x 17.8cm (L W 14" H 7")

D.W. Haber Square Flat Basket
DWFBWDBASK2SAG
 35.6cm (L W 14")
 Hinged Acrylic Lid
DWFB14CVRH ● (LW 14") Clear



Folio Azores Costa Plate
6210FA002
 D 20.25cm (8 1/4")
 Not available in the UK

D.W. Haber
 Grey Marble Resin Tile
DWKFB1212GM
 30.5cm (L W 12" H 3/8")

D.W. Haber Polished SS Riser
DW07311212SS
 30.5cm x 5.0cm (L W 12" H 2")

D.W. Haber Ash Grey Teak
 Fusion Buffet Riser Gastronorm
DWFB20127WDAG
 58.4 x 38.1 x 18.4cm (L 23" W 15" H 7 1/4")

Creations Melamine
 Craft White Rectangle Platter
68A416EL591
 530mm x 325mm (L 21" W 12 3/4")

D.W. Haber Bakery Split Cover
7345MW150
 54.6cm x 34.9cm (L 21 1/2" W 13 3/4")

D.W. Haber Ash Grey Teak
 Square Riser
DWFB147WDAG
 35.6cm x 17.8cm (L W 14" H 7")

D.W. Haber
 Fusion Aluminium Square Bowl
DWFCAB19W
 48.3cm (L W 19" H 4")

D.W. Haber Fido Clear Jar
4949Q458 (7 3/4oz)

D.W. Haber Black Shelf Holder
DWFBUSHT4

D.W. Haber
 Grey Marble Resin Tile
DWKFB1414GM
 35.6cm (L W 14" H 3/8")

D.W. Haber Ash Grey Teak
 Square Riser
DWFB612WDAG
 15.2cm x 30.5cm (L W 6" H 12")

D.W. Haber
 Grey Marble Resin Tile
DWFB666GM
 15.2cm (L W 6" H 3/8")

D.W. Haber Ash Grey Teak
 Angled Square Bread Basket
DWFBWDBASK1SAG
 35.6cm (L W 14")

D.W. Haber Ash Grey Teak
 Square Riser
DWFB145WDAG
 35.6cm x 12.7cm (L W 14" H 5")

D.W. Haber Ash Grey Teak
 Square Riser
DWFB66WDAG
 15.2cm x 15.2cm (L W 6" H 6")

D.W. Haber Ash Grey Teak
 Wood Square Tile
DWFBWD66SAG
 L W 15.2cm (6")



ash grey teak



Square Riser
DWFB147WDAG
35.6cm x 17.8cm (L W 14" H 7")



Square Riser
DWFB145WDAG
35.6cm x 12.7cm (L W 14" H 5")



Fusion Buffet Riser Gastronorm
DWFB20127WDAG*
58.4 x 38.1 x 18.4cm H (23" x 15" x 7 1/4" H)
(Fits EL590, EL591 Gastronorm Trays)



Low Profile Gastronorm Riser **NEW**
DWFB21132WDAG* ●
58.4 x 38.1 x 7.9cm (L 23" W 15" H 3 1/8")
(Fits EL590, EL591 Gastronorm Trays & DWFB20ICESET Ice Cell)



Rectangle Tile
DWFBWD2411SAG
60.9cm x 27.9cm (L 24" W 11")



Square Tile
DWFBWD1414SAG 35.6cm (L W 14")
DWFBWD1212SAG 30.5cm (L W 12")
DWFBWD1111SAG 27.9cm (L W 11")
DWFBWD66SAG 15.2cm (L W 6")



3 Piece Riser Set
DWRISERS3WDAG
58.4cm (L 23" W 6")
in 3 Heights: 1 1/2", 3 1/2", 5 1/2"



Square Riser
DWFB116WDAG
27.9cm x 15.2cm (L W 11" H 6")
Square Grill
DWFB11GRILL ● 27.9cm (L W 11")



Square Riser
DWFB612WDAG
15.2cm x 30.5cm (L W 6" H 12")



Square Riser
DWFB66WDAG
15.2cm x 15.2cm (L W 6" H 6")



Angled Square Bread Basket
DWFBWDBASK1SAG
35.6cm (L W 14")



Square Flat Basket
DWFBWDBASK2SAG
35.6cm (L W 14")



Stackable Bakery Box with Acrylic Drawer **NEW**
DWFBWDBDAG
36.2cm x 21.6cm (L 14 1/4" x W 8 1/2" H 8")



Universal stand fits 3 size containers

Juicer w/Ash Grey Teak Wood Base
DW12JLWDAG 11.4L (12qt)
Juicer w/Ash Grey Teak Wood Base
DW07JLWDAG 6.6L (7qt)
Juicer w/Ash Grey Teak Wood Base
DW04JLWDAG 3.8L (4qt)



*All Creations Gastronorm Trays fit in the Fusion Buffet Gastronorm Risers.

D=Diameter L=Length W=Width H=Height • All products are measured at max capacity. See pages 123-125 for all Fusion Buffet insert options.

See pages 123-125 for all Fusion Buffet insert options.

D=Diameter L=Length W=Width H=Height • All Products are Measured at Max Capacity (oz)

● Non-Stock ● Stocked in European Warehouse



grey wash teak



Square Riser
DWFB147WDGW
35.6cm x 17.8cm (L W 14" H 7")



Square Riser
DWFB145WDGW
35.6cm x 12.7cm (L W 14" H 5")



Gastronorm Buffet Riser
DWFB20127WDGW[^]
58.4 x 38.1 x 18.4cm H (23" x 15" x 7 1/4" H)
(Fits EL590, EL591 Gastronorm Trays)



Low Profile Gastronorm Riser **NEW**
DWFB21132WDGW[^] ●
58.4 x 38.1 x 7.9cm (L 23" W 15" H 3 1/8")
(Fits EL590, EL591 Gastronorm Trays & DWFB20ICESET Ice Cell)



Rectangle Tile
DWFBWD2411SGW
60.9cm x 27.9cm (L 24" W 11")



Square Tile
DWFBWD1414SGW 35.6cm (L W 14")
DWFBWD1212SGW 30.5cm (L W 12")
DWFBWD1111SGW 27.9cm (L W 11")
DWFBWD666SGW 15.2cm (L W 6")



3 Piece Riser Set
DWRISERS3WDGW
58.4cm (L 23" W 6")
in 3 Heights: 1 1/2", 3 1/2", 5 1/2"



Square Riser
DWFB116WDGW
27.9cm x 15.2cm (L W 11" H 6")
Square Grill
DWFB11GRILL ● 27.9cm (L W 11")



Square Riser
DWFB612WDGW
15.2cm x 30.5cm
(L W 6" H 12")



Square Riser
DWFB666WDGW
15.2cm x 15.2cm
(L W 6" H 6")



Square Bread Basket Angled
DWFBWDBASK1SGW
35.6cm (L W 14")



Square Flat Basket
DWFBWDBASK2SGW
35.6cm (L W 14")



Stackable Bakery Box with Acrylic Drawer **NEW**
DWFBWDBDGW
36.2cm x 21.6cm
(L 14 1/4" x W 8 1/2" H 8")



Universal stand fits 3 size containers

- Juicer w/Grey Wash Teak Wood Base
DW12JLWDGW 11.4L (12qt)
- Juicer w/Grey Wash Teak Wood Base
DW07JLWDGW 6.6L (7qt)
- Juicer w/Grey Wash Teak Wood Base
DW04JLWDGW 3.8L (4qt)



[^]All Creations Gastronorm Trays fit in the Fusion Buffet Gastronorm Risers.

D=Diameter L=Length W=Width H=Height • All products are measured at max capacity. See pages 123-125 for all Fusion Buffet insert options.

See pages 123-125 for all Fusion Buffet insert options.

D=Diameter L=Length W=Width H=Height • All Products are Measured at Max Capacity (oz)

● Non-Stock ● Stocked in European Warehouse



natural teak



Square Riser
DWFB147WDT ●
35.6cm x 17.8cm (L W 14" H 7")



Square Riser
DWFB145WDT ●
35.6cm x 12.7cm (L W 14" H 5")



Gastronorm Buffet Riser
DWFB20127WDT ●
58.4 x 38.1 x 18.4cm H (23" x 15" x 7 1/4" H)
(Fits EL590, EL591 Gastronorm Trays)



Low Profile Gastronorm Riser **NEW**
DWFB21132WDT ●
58.4 x 38.1 x 7.9cm (L 23" W 15" H 3 1/8")
(Fits EL590, EL591 Gastronorm Trays & DWFB20ICESET Ice Cell)



Rectangle Tile
DWFBWD2411ST ●
60.9cm x 27.9cm (L 24" W 11")



Square Tile
DWFBWD1414ST ● 35.6cm (L W 14")
DWFBWD1212ST ● 30.5cm (L W 12")
DWFBWD1111ST ● 27.9cm (L W 11")
DWFBWD66ST ● 15.2cm (L W 6")



3 Piece Riser Set
DWRISERS3WDT ●
58.4cm (L 23" W 6")
in 3 Heights: 1 1/2", 3 1/2", 5 1/2"



Square Riser
DWFB116WDT ●
27.9cm x 15.2cm (L W 11" H 6")
Square Grill
DWFB11GRILL ● 27.9cm (L W 11")



Square Riser
DWFB612WDT ●
15.2cm x 30.5cm
(L W 6" H 12")



Square Riser
DWFB66WDT ●
15.2cm x 15.2cm
(L W 6" H 6")



Angled Square Bread Basket
DWFBWDBASK1ST ●
35.6cm (L W 14")



Square Flat Basket
DWFBWDBASK2ST ●
35.6cm (L W 14")



Stackable Bakery Box
with Acrylic Drawer **NEW**
DWFBWDBDT ●
36.2cm x 21.6cm
(L 14 1/4" x W 8 1/2" H 8")



Universal stand fits 3 size containers

- Juicer w/Natural Teak Wood Base
DW12JLWDT ● 11.4L (12qt)
- Juicer w/Natural Teak Wood Base
DW07JLWDT ● 6.6L (7qt)
- Juicer w/Natural Teak Wood Base
DW04JLWDT ● 3.8L (4qt)



*All Creations Gastronorm Trays fit in the Fusion Buffet Gastronorm Risers.

D=Diameter L=Length W=Width H=Height • All products are measured at max capacity. See pages 123-125 for all Fusion Buffet insert options.

See pages 123-125 for all Fusion Buffet insert options.

D=Diameter L=Length W=Width H=Height • All Products are Measured at Max Capacity (oz)

● Non-Stock ● Stocked in European Warehouse



black teflon Proprietary black teflon coating eliminates finger prints and gives a unique feel to the Fusion Buffet System.

stainless steel

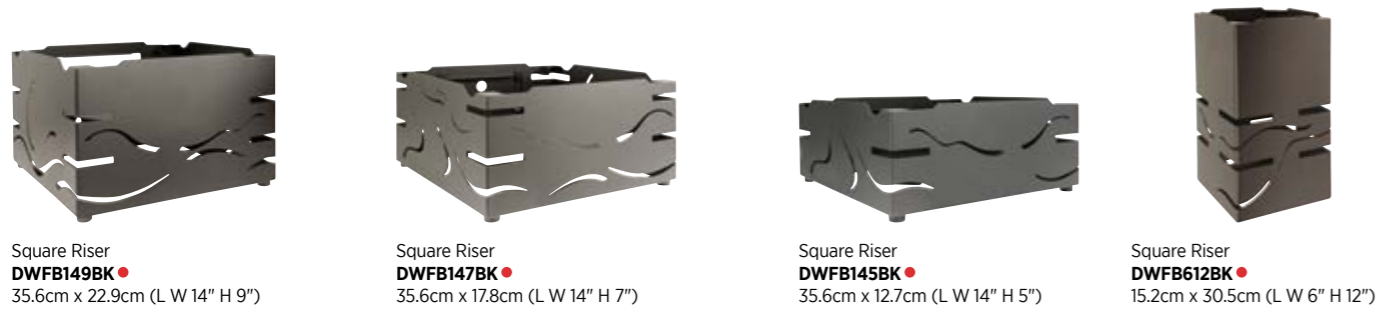

Square Riser **DWFB149BK** • 35.6cm x 22.9cm (L W 14" H 9")
 Square Riser **DWFB147BK** • 35.6cm x 17.8cm (L W 14" H 7")
 Square Riser **DWFB145BK** • 35.6cm x 12.7cm (L W 14" H 5")
 Square Riser **DWFB12BK** • 15.2cm x 30.5cm (L W 6" H 12")

Square Riser **DWFB149** • 35.6cm x 22.9cm (L W 14" H 9")
 Square Riser **DWFB147** • 35.6cm x 17.8cm (L W 14" H 7")
 Square Riser **DWFB145** • 35.6cm x 12.7cm (L W 14" H 5")
 Square Riser **DWFB12** • 15.2cm x 30.5cm (L W 6" H 12")
 Fusion Ice Box w/Plastic Insert **DWFB20128P** • 50.8cm (L 20" W 12" H 8")

mini riser grill stands



Mini Riser w/ Grill **DWGB99GBK** • 22.9cm (L W 9" H 9")
 Mini Riser w/ Grill **DWGB76GBK** • 19.0cm (L W 7½" H 6")

Design an elevated juicer station with built-in features such as two different heights, three interchangeable size juice vessels, all-metal taps, a centre ice well to keep juice cold, and reversible risers for dual use.



Juicer **DW12JLFBMOD7SS** • L 12" W 12" H 25" 13.6L (12qt) (H 7" Stand)
 Juicer **DW07JLFBMOD7SS** • L 12" W 12" H 21" 8.5L (7¼qt) (H 7" Stand)
 Juicer **DW04JLFBMOD7SS** • L 12" W 12" H 17" 4.5L (4qt) (H 7" Stand)
 Juicer **DW12JLFBMOD9SS** • L 12" W 12" H 27" 13.6L (12qt) (H 9" Stand)
 Juicer **DW07JLFBMOD9SS** • L 12" W 12" H 23" 8.5L (7¼qt) (H 9" Stand)
 Juicer **DW04JLFBMOD9SS** • L 12" W 12" H 20" 4.5L (4qt) (H 9" Stand)

See pages 123-125 for all Fusion Buffet insert options.

D=Diameter L=Length W=Width H=Height • All Products are Measured at Max Capacity (oz)

• Non-Stock



black teflon risers

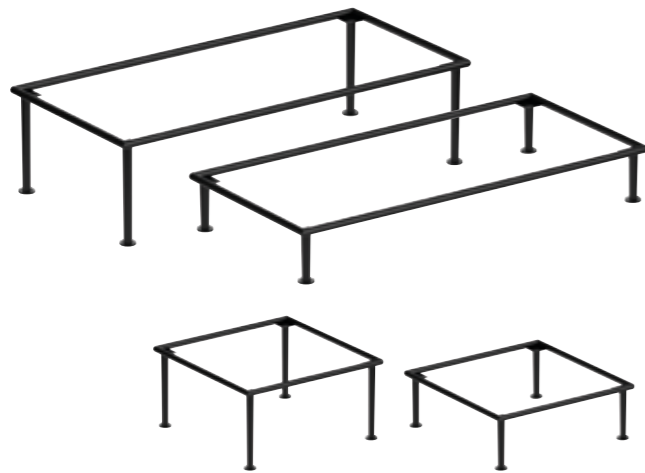

Black Teflon Riser
DW073124116BK
61.0 x 28.0 x 15.25cm
(L 24" W 11" H 6")

Black Teflon Riser
DW073124113BK
61.0 x 28.0 x 7.6cm
(L 24" W 11" H 3")

Black Teflon Riser
DW073112126BK
30.5cm x 15.25cm
(L W 12" H 6")

Black Teflon Riser
DW073112124BK
30.5cm x 10.0cm
(L W 12" H 4")

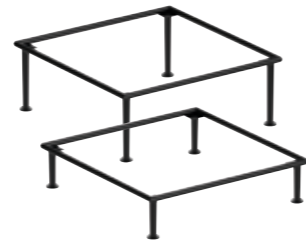

Black Teflon Riser
DW073114145BK ●
35.6cm x 12.75cm
(L W 14" H 5")

Black Teflon Riser
DW073114143BK ●
35.6cm x 7.6cm
(L W 14" H 3")

Black Teflon Riser
DW0731666BK
15.2cm x 15.2cm
(L W 6" H 6")

Black Teflon Riser
DW0731664BK
15.2cm x 10.0cm
(L W 6" H 4")

polished stainless steel risers

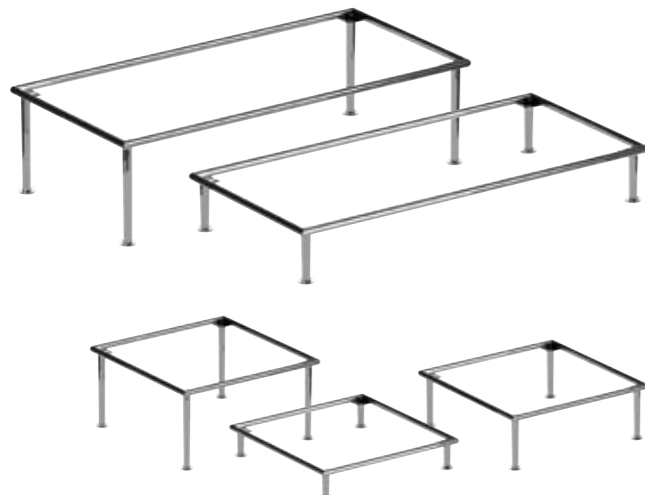

Polished SS Riser
DW073124116SS
61.0 x 28.0 x 15.25cm
(L 24" W 11" H 6")

Polished SS Riser
DW073124113SS
61.0 x 28.0 x 7.6cm
(L 24" W 11" H 3")

Polished SS Riser
DW073112126SS
30.5cm x 15.25cm
(L W 12" H 6")

Polished SS Riser
DW073112124SS
30.5cm x 10.0cm
(L W 12" H 4")

Polished SS Riser
DW073112122SS
30.5cm x 5.0cm
(L W 12" H 2")



Polished SS Riser
DW073114145SS ●
35.6cm x 12.75cm
(L W 14" H 5")

Polished SS Riser
DW073114143SS
35.6cm x 7.6cm
(L W 14" H 3")

Polished SS Riser
DW0731666SS
15.2cm x 15.2cm
(L W 6" H 6")

Polished SS Riser
DW0731664SS
15.2cm x 10.0cm
(L W 6" H 4")



resin tiles & shelves

Resin tiles are durable, non-absorbent, and food and dishwasher safe.



wood tiles & shelves

Durable teak wood



glass tiles & shelves

Tempered glass

elevate your buffet presentation

The perfect addition to the Fusion Buffet System are the black Teflon and stainless steel square and rectangle risers. These multi-sized, elevated frames offer beauty and height for your presentation, and are presented with interchangeable inserts in resin, teak wood and tempered glass.

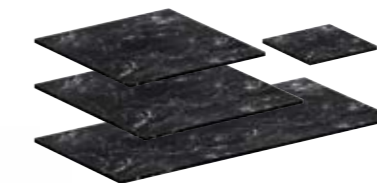

Grey Marble Resin Square Tile
DWKFBI414GM 35.6cm (L W 14" H 3/8")
DWKFBI212GM 30.5cm (L W 12" H 3/8")
DWKFBI66GM 15.2cm (L W 6" H 3/8")
Grey Marble Resin Rectangle Tile
DWKFBI2411GM 60.9cm x 27.9cm (L 24" W 11" H 3/8")

resin tiles & shelves



Carrera Resin Square Tile
DWKFBI414CAR 35.6cm (L W 14" H 3/8")
DWKFBI212CAR 30.5cm (L W 12" H 3/8")
DWKFBI66CAR 15.2cm (L W 6" H 3/8")
Carrera Resin Rectangle Tile
DWKFBI2411CAR 60.9cm x 27.9cm (L 24" W 11" H 3/8")

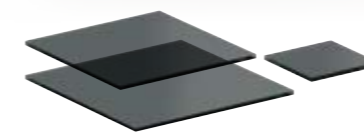

Black Glass Square Tile
DWFBGL14BK 35.6cm (L W 14" H 3/8")
DWFBGL12BK 30.5cm (L W 12" H 3/8")
DWFBGL6BK 15.2cm (L W 6" H 3/8")
Black Glass Rectangle Tile
DWFBGL3611BK 91.4cm x 27.9cm (L 36" W 11" H 3/8")
DWFBGL3607BK 91.4cm x 17.8cm (L 36" W 7" H 3/8")
DWFBGL2411BK 60.9cm x 27.9cm (L 24" W 11" H 3/8")
DWFBGL2407BK 60.9cm x 17.8cm (L 24" W 7" H 3/8")



Clear Glass Square Tile
DWFBGL14 35.6cm (L W 14" H 3/8")
DWFBGL6 15.2cm (L W 6" H 3/8")
Clear Glass Rectangle Tile
DWFBGL3611 91.4cm x 27.9cm (L 36" W 11" H 3/8")
DWFBGL3607 91.4cm x 17.8cm (L 36" W 7" H 3/8")
DWFBGL2411 60.9cm x 27.9cm (L 24" W 11" H 3/8")
DWFBGL2407 60.9cm x 17.8cm (L 24" W 7" H 3/8")

glass tiles & shelves



Frosted Glass Square Tile
DWFBGL14F 35.6cm (L W 14" H 3/8")
DWFBGL12F 30.5cm (L W 12" H 3/8")
DWFBGL6F 15.2cm (L W 6" H 3/8")
Frosted Glass Rectangle Tile
DWFBGL2411F 60.9cm x 27.9cm (L 24" W 11" H 3/8")

wood tiles & shelves



Ash Grey Teak Wood Square Tile
DWFBWD1414SAG 35.6cm (L W 14")
DWFBWD1212SAG 30.5cm (L W 12")
DWFBWD1111SAG 27.9cm (L W 11")
DWFBWD66SAG 15.2cm (L W 6")
Ash Grey Teak Wood Rectangle Tile
DWFBWD2411SAG 60.9cm x 27.9cm (L 24" W 11")



Grey Wash Teak Wood Square Tile
DWFBWD1414SGW 35.6cm (L W 14")
DWFBWD1212SGW 30.5cm (L W 12")
DWFBWD1111SGW 27.9cm (L W 11")
DWFBWD66SGW 15.2cm (L W 6")
Grey Wash Teak Wood Rectangle Tile
DWFBWD2411SGW 60.9cm x 27.9cm (L 24" W 11")



Natural Teak Wood Square Tile
DWFBWD1414ST 35.6cm (L W 14")
DWFBWD1212ST 30.5cm (L W 12")
DWFBWD1111ST 27.9cm (L W 11")
DWFBWD66ST 15.2cm (L W 6")
Natural Teak Wood Rectangle Tile
DWFBWD2411ST 60.9cm x 27.9cm (L 24" W 11")

See pages 123-125 for all Fusion Buffet insert options.

D=Diameter L=Length W=Width H=Height • All Products are Measured at Max Capacity (oz)

● Non-Stock ● Stocked in European Warehouse

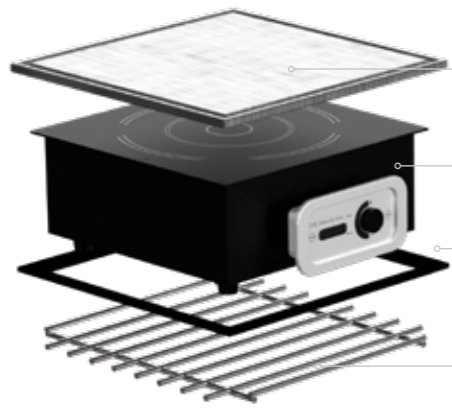

hot buffet

- Aluminium Hot Plate**
DWFB14ALUM ●
For use with metal risers only
- Induction Ready**
DWELIN300B Warmer 300 Watt (2.5 amp, 120v)
DWELIN1800B Range 1800 Watt (15 amp, 120v)
- Black Induction Adapter Ring**
DWFB14ADAPBK ●
Required for Induction when used with the 14" teak risers
- Square Grill**
DWFB14GRILL ●



ambient buffet

- Hinged Acrylic Lid**
DWFB14CVRH ●
- Flat Wood Basket**
DWFBWDBASK2SAG Ash Grey Teak
Also available as angled wood basket
Available in three finishes:
Grey Wash, Ash Grey & Natural Teak
- Square Tiles**
DWKFB1414GM Grey Marble Resin
Available in wood, glass and resin



cold buffet

- Aluminium Square Bowl**
Available in two heights:
DWFCAB19W ● L W 19" H 4"
DWFCAB16W ● L W 16" H 2"
 - Aluminium Divided Square Bowl**
DWFCAB16DW ● L W 16" H 2"
 - Square Wood Riser**
DWFB147WDAG Ash Grey Teak L W 14" H 7"
DWFB145WDAG Ash Grey Teak L W 14" H 5"
Available in three finishes:
Grey Wash, Ash Grey & Natural Teak
- Also Available: **Square Metal Riser**
Available in three heights: 5", 7" and 9"
Available in two finishes:
Stainless Steel & Black Teflon

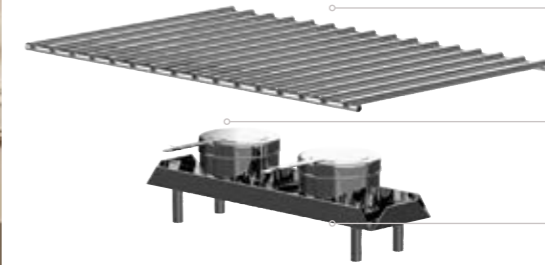

hot buffet

- Stainless Steel Fusion Grill**
for Gastronorm Riser
DWFB20GRILL ● L 21¼" W 13¼"
- Fuel Holder DW01001 ●**
- Fusion Fuel Shelf**
for Gastronorm Riser Stainless Steel
(Fuel Holders Not Included)
DWFB20SHELF ● L 14½" W 4"



ambient buffet

- Bakery Split Cover**
7345MW150 ●
L 21½" W 13¾"
- Slate Rectangle Platter**
68A415EL591 ● L 21" W 12¾"
Available in: Slate, Driftwood & Craft White



cold buffet

- DWFBGN1 ●**
Ice Cell Gastronorm
White Rectangle Platter 1/1 **NEW**
 - DWFB20ICESET ●**
Ice Cell Set **NEW**
Set Includes 1 Tray,
2 Cooling Blocks and
2 Buffer Pouches
 - Ice Bin for Gastronorm Risers**
DW08WP6PL ●
L 20 7/8" W 12 3/4" H 6"
 - Fusion Buffet Riser Gastronorm**
DWFB20127WDAG
Ash Grey Teak L 23" W 15" H 7¼"
Available in three finishes:
Grey Wash, Ash Grey & Natural Teak
- Also Available:
- Low Profile Gastronorm Riser ● NEW**
L 23" W 15" H 3 1/8"
Available in three finishes: Grey Wash,
Ash Grey & Natural Teak





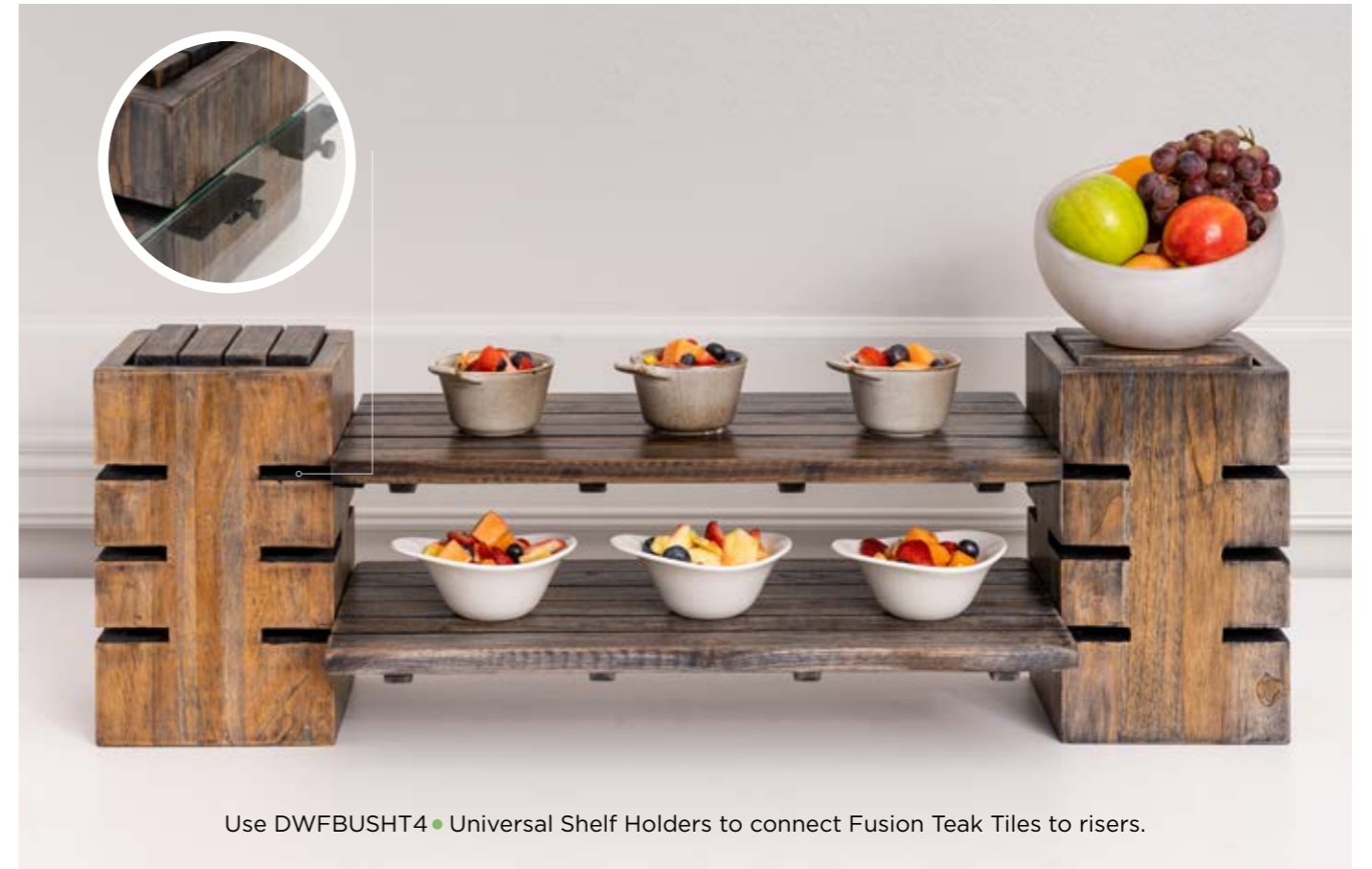

Use DWFBUSHT4 • Universal Shelf Holders to connect Fusion Teak Tiles to risers.



Use the corner notches on the risers to insert Fusion Tiles at 3 different heights on a 45° angle.



introducing the d.w. haber ice cell

The perfect solution for keeping your buffet food fresh and chilled for extended periods! This innovative chilling system is designed to keep food cold for at least 3 hours, ensuring freshness and quality. Keeping food at the right temperature is crucial to prevent bacterial growth and maintain its taste and texture. The D.W. Haber Ice Cell is specifically designed to fit the standard and low profile Fusion Gastronom risers, available in 3 finishes: Ash Grey, Grey Wash, and Natural Teak wood.



1. Store the cooling blocks in the freezer overnight for the best results.



2. Place the cooling blocks in the BPA free tray, and set the temperature equalisers on top of the blocks to maintain even cold distribution.



3. Add the porcelain Gastronom platter and enjoy chilled food for at least 3 hours.



DWFB20ICESET ●

Set includes: 1 Plastic Tray which fits into a Riser, 2 Cooling Blocks and 2 Buffer Pouches. Gastronom Platters and Risers sold separately.

- DWFBGN1** ● Gastronom White Rectangle Platter 1/1
- DWFBGN12** ● Gastronom White Rectangle Platter 1/2
- DWFBGCBP** Buffer Pouch L 10 7/8" W 9 1/2" H 1 1/4"
- DWFBGCGN12ICE** Cooling Block L 10 1/2" W 9 7/8" H 9 7/8"
- DWFBGCGNTRAY** Tray Plastic L 20 1/2" W 12 5/8" H 1 1/4"

- Gastronom Buffet Riser
- 58.4 x 38.1 x 18.4cm H (23" x 15" x 7 1/4" H)
- DWFB20127WDT** ● Natural Teak
- DWFB20127WDAG** ● Ash Grey Teak
- DWFB20127WDGW** ● Grey Wash Teak

NEW D.W. HABER *ice cell*



- Low Profile Gastronom Riser
- 58.4 x 38.1 x 7.9cm (L 23" W 15" H 3 1/8")
- DWFB21132WDT** ● Natural Teak
- DWFB21132WDAG** ● Ash Grey Teak
- DWFB21132WDGW** ● Grey Wash Teak



fusion hot buffet inserts & accessories

Induction Range **1800** Watt
34.3 x 31.8 x 11.4cm H
(13½" x 12½" x 4½" H)
1800w/220V
DWELIN1800BE2 ● EU PLUG
DWELIN1800BE3 UK PLUG
Induction Warmer **300** Watt
300w/220V
DWELIN300BE2 ● EU PLUG
DWELIN300BE3 UK PLUG

Black Fusion Induction Adapter Ring
DWFB14ADAPBK ● 35.6cm (14")
(Required for Induction when used with the 14" teak risers)

Power Cell Cordless Induction Range Patent-Pending **NEW**
220V EU & UK Plug
DWELINPCE2E3 ● L 37.1cm x W 33.0cm (L 14½" W 13" H 3")
Travel Case
DWELINPCCASE ● **NEW**
L 19" W 15⅞" H 7⅞"

Power Cell Cover Up **NEW**
L 42.8 x W 38.1 x H 9.5cm (L 16⅞" W 15" H 3¾")
DWFB15133WDAG ● Ash Grey Teak
DWFB15133WDT ● Natural Teak
DWFB15133WDGW ● Grey Wash Teak

Fusion Grill for Gastronorm Riser
Stainless Steel
DWFB20GRILL ●
L 21¼" W 13¼"

Square Grill
DWFB14GRILL ●
35.6cm (L W 14")

Square Grill
DWFB11GRILL ●
27.9cm (L W 11")

Square Aluminium Hot Plate (Not recommended for use on Wood Risers)
DWFB14ALUM ● 35.6cm (L W 14")

Fuel Shelf for Fusion Gastronorm Riser (Fuel Holders Not Included)
DWFB20SHELF ● L 14½" W 4"
Fuel Holder **DW01001** ●

fusion ambient buffet inserts & accessories

Bakery Split Cover
7345MW150 ●
54.6cm x 34.9cm (L 21½" W 13¾")
Fits EL590, EL591, DW08WP6PL

Hinged Acrylic Lid
DWFB14CVRH ●
35.6cm (L W 14") Clear
Fits 14" Fusion Square Risers

fusion cold buffet inserts & accessories

Fusion Aluminium Square Bowl
DWFCAB19W ● 48.3cm (L W 19" H 4")
(Fits 14" Fusion Riser)
Custom Powder Coating Available

Fusion Aluminium Square Bowl
DWFCAB16W ● 40.6cm (L W 16" H 2")
(Fits 14" Fusion Riser)
Custom Powder Coating Available

Fusion Aluminium Divided Square Bowl
DWFCAB16DW ● 40.6cm (L W 16" H 2")
(Fits 14" Fusion Riser)
Custom Powder Coating Available

Ice Bin for Gastronorm Risers
DW08WP6PL ●
50.8 x 30.5 x 15.2cm (L 20⅞" W 12¾" H 6")
(Fits DWFB20127)



additional fusion buffet inserts & accessories

Satin Universal Cover Holder
DW396CVRHOLD1 ●
27.7cm x 11.4cm (L 11" H 4½")

Satin Adapter Clip to Attach Cover Holder for Wood Fusion Risers
DWFB14CLIPHOLD1 ●

Attachable Utensil Holder for Wood Fusion Risers
DWFBREST2 ●
24.1cm (L 9½" W 4⅝")

Attachable Utensil Holder for Metal Fusion Risers
DWFBREST ●
24.1cm (L 9½" W 4⅝")

Black Universal Shelf Holder for Teak Fusion Risers
DWFBUSHT4 ●
Includes 4 pieces. Fits all teak risers and holds glass, resin or wood tiles

Stainless Steel Hanging Card Holder for Fusion Wood Risers
DW07373HK2SS ●
9.8cm (L 3⅞" W 2⅝")

Black Hanging Card Holder for Fusion Wood Risers
DW07373HK2BK ●
9.8cm (L 3⅞" W 2⅝")

Stainless Steel Hanging Card Holder for Fusion Metal Risers
DW07373HK2SS ●
9.8cm (L 3⅞" W 2⅝")

Stainless Steel Freestanding Card Holder
DW07372SS ●
9.8cm (L 3⅞" W 2⅝")

Black Freestanding Card Holder
DW07372BK ●
9.8cm (L 3⅞" W 2⅝")

D.W. HABER *storage carts*

Black powder coated storage and transport cart ideal for Fusion risers. Easy to manoeuvre with adjustable shelves.

Hammered Spoon Rest
DW394SRM ●
13.4cm (L 5¼" W 3¾" H 3")

Spoon Rest
DW394SR ●
13.4cm (L 5¼" W 3¾" H 3")

Drip Tray w/Drainer
DW08WP6PL ●
D 13.4cm (5¼")

Square Drip Tray w/Drainer
DWDRIP5QSETSS ●
L W 12.7cm (5")

Large Cart for Fusion Risers (Risers not included)
DWFCARTLGI ●
182.9 x 86.4 x 155.0cm (L 72" W 34" H 61")
8" Wheels

Mini Cart for Fusion Risers (Risers not included)
DWFCART2 ●
114.3 x 76.2 x 111.75cm (L 45" W 30" H 44")
5" Wheels



bringing foodservice displays to new heights

D.W. Haber tiered stands are the perfect addition to buffets or food stations. With 4 and 5-level options, these stands have an elegant look and are designed with no screws or parts, so they are easy to assemble or replace & replenish glass shelves during service. The stands have the ability to showcase multiple dishes at once, so they are perfectly designed for numerous grab & go desserts, a back bar station for glassware, and more. The options are as vast as your creativity.



White Wave 4 Tier Presentation Display
DW412WVW ●
Overall dimensions with glass shelves
101.6 x 40.6 x 64.8cm
(L 40" W 16" H 25½")



Black Wave 4 Tier Presentation Display
DW412WVK ●
Overall dimensions with glass shelves
101.6 x 40.6 x 64.8cm
(L 40" W 16" H 25½")



Fusion Mini Cart
DWFCART2 ●
Fits up to 4 Wave Sets
114.3 x 76.2 x 111.75cm
(L 45" W 30" H 44")
Removable centre shelf (not shown) & double glass storage
Can also fit 2 Waves in addition to Fusion Package (Risers not included)



5 Tier Presentation Display Stand w/Clear Glass
DW5TC ● 91.4cm x 28.0cm x 104.1cm (L 36" W 11" H 41")
(Some assembly required)



5 Tier Presentation Display Stand w/Black Glass
DW5TBK ● 91.4cm x 28.0cm x 104.1cm (L 36" W 11" H 41")
(Some assembly required)



Oval Faceted Acacia Board
6525TW321
71.1 x 30.5 x 5.0cm (28" x 12" x 2" h)



Square Faceted Acacia Board
6525TW322
38.1 x 38.1 x 5.0cm (15" x 15" x 2" h)

elevate your buffet presentation

Bring your buffet to new heights with the wood offerings from Creations Buffet. Available in various shapes and sizes, these platforms offer a unique and exciting solution for your foodservice presentation. Designed from acacia wood, the serving boards are strong, durable, and resistant to staining, while providing a look that will attract the eyes of your guests every time.



*wood platform
dimensions*

- (1) Base D 14"
- (2) Platform D 10"
- (2) Platform D 8"
- (1) Platform D 6"
- Light Assembly Required



buffet presentation reaching new heights

Handcrafted in the USA, these beautifully unique, vertical stands are like no other! Utilising mixed mediums of industrial pipe and wood, these display stands offer height and mobility for visually pleasing presentations. Available in three distinct finishes, the pipe arms are movable and can be adjusted for a variety of display options. Great for a multitude of uses from coffee & tea service to pastries and fruit smoothies to small appetizers, you can accessorise your display stand with an unlimited variety of small plates, cups, dishes, etc. that Steelite has to offer.



- 3-Tier Stand With Pipe Legs
35.6cm x 66.0cm (D 14" x H 26")
Platforms:
35.6cm (14"), 25.4cm (10"), 20.3cm (8")
6525T204 Ebony
6525T200 Chestnut
6525T208 Aged White
- 3-Tier Stand
35.6cm x 52.7cm (D 14" H 20¾")
Platforms:
35.6cm (14"), 25.4cm (10"), 20.3cm (8")
6525T205 Ebony
6525T201 Chestnut
6525T209 Aged White



- Platform Stand With Pipe Legs
35.6cm x 12.1cm (D 14" H 4¾")
6525T207 Ebony
6525T203 Chestnut
6525T211 Aged White
- Fits Creations Polycrystal Cloche
7100DR063 • (D 10" H 7")
- Platform Stand With Pipe Legs
35.6cm x 17.1cm (D 14" H 6¾")
6525T206 Ebony
6525T202 Chestnut
6525T210 Aged White
- Fits Creations Polycrystal Cloche
7100DR063 • (D 10" H 7")



- Display Stand
6525T074 35.5cm x 61.5cm H (14" x 24¼" H)
Gun Metal Pipes
Ebony Stain Wood



- Display Stand
6525T072 35.5cm x 61.5cm H (14" x 24¼" H)
Gun Metal Pipes
Chestnut Stain Wood



- Display Stand
6525T073 35.5cm x 61.5cm H (14" x 24¼" H)
White Pipes
Weathered White Wood



high quality design & durability

Introducing Roselli Resin Risers, these round & square raised vessels not only provide functionality but durability as well. Made of commercial grade resin, these one-piece risers are resistant to stains, are dishwasher safe, and will not warp over time. A great addition to any buffet presentation, these versatile risers are designed for both hot & cold foods and are available in Smoked Paprika & Basalt colours.



Large Pedestal Bowl Stand
Smoked Paprika
7700ER001 ●
D 16" H 10¾"
7700ER002 ●
D 11¼" H 8½"

Flat Round Stand w/Coupe Edge
Smoked Paprika
7700ER003 ●
L W 17½" H 9½"

Flat Square Stand w/Coupe Edge
Smoked Paprika
7700ER004 ●
L W 12¾" H 7"

Large Pedestal Bowl Stand
Basalt
7710ER001 ●
D 16" H 10¾"
7710ER002 ●
D 11¼" H 8½"

Flat Round Stand w/Coupe Edge
Basalt
7710ER003 ●
L W 17½" H 9½"

Flat Square Stand w/Coupe Edge
Basalt
7710ER004 ●
L W 12¾" H 7"

D=Diameter L=Length W=Width H=Height • All Products are Measured at Max Capacity (oz)

● Non-Stock



modern design with form & function in mind

Ultra-modern risers by Roselli Design will take your buffet and tabletop presentation to new heights. Available in a bright white porcelain, each riser will elevate both sweet and savoury culinary presentations.



Coupe
6950E702 Small
24.0cm w x 11.5cm h (9½" w x 4½" h)

Round
6950E706 Large
37.0cm w x 20.25cm h (14½" w x 8" h)
6950E707 Medium
29.0cm w x 16.5cm h (11½" w x 6½" h)
Fits Creations Polycrystal Cloche
7100DR063 • D 10" H 7"
6950E708 Small
24.0cm w x 11.5cm h (9½" w x 4½" h)

Square
6950E703 Large
37.0cm w x 20.25cm h (14½" w x 8" h)
6950E704 Medium
29.0cm w x 16.5cm h (11½" w x 6½" h)
6950E705 Small
24.0cm w x 11.5cm h (9½" w x 4½" h)



unique resin designs for the table & beyond

From the table to the guest room, Kenny Mack Designs handmade resin risers sit beautifully in diverse hospitality settings. Elevate your aesthetic with functional form and designs of Kenny Mack resin.

carved risers

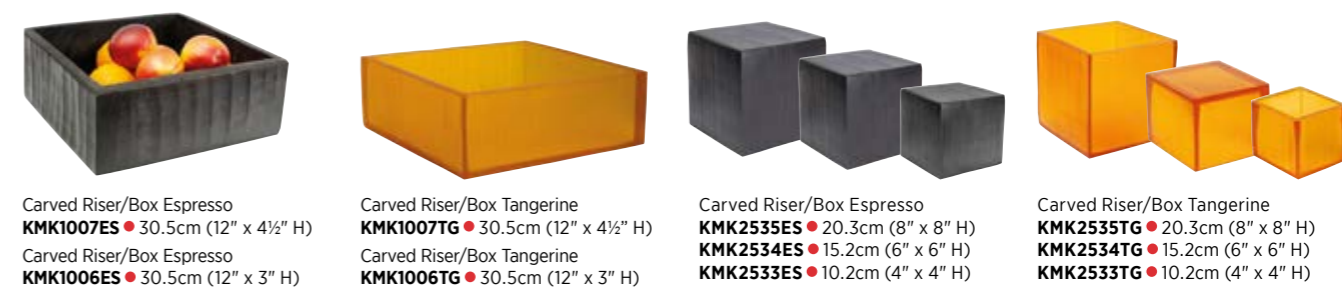

Carved Riser/Box Espresso
KMK1007ES • 30.5cm (12" x 4½" H)
Carved Riser/Box Espresso
KMK1006ES • 30.5cm (12" x 3" H)

Carved Riser/Box Tangerine
KMK1007TG • 30.5cm (12" x 4½" H)
Carved Riser/Box Tangerine
KMK1006TG • 30.5cm (12" x 3" H)

Carved Riser/Box Espresso
KMK2535ES • 20.3cm (8" x 8" H)
KMK2534ES • 15.2cm (6" x 6" H)
KMK2533ES • 10.2cm (4" x 4" H)

Carved Riser/Box Tangerine
KMK2535TG • 20.3cm (8" x 8" H)
KMK2534TG • 15.2cm (6" x 6" H)
KMK2533TG • 10.2cm (4" x 4" H)

smooth risers



Smooth Riser/Box Shell
KMK1006SH • 30.5cm (12" x 3" H)

Smooth Riser/Box Shell
KMK1007SH • 30.5cm (12" x 4½" H)

Smooth Riser/Box Shell
KMK2534SH • 15.2cm (6" x 5" H)

Smooth Riser/Box Shell
KMK2533SH • 10.2cm (4" x 4" H)



Platters & Bowls

With a range of options available including square & rectangle plates, large bowls, sharing platters and gastronorm trays, Steelite International offers a number of serving vessels which are perfectly suited for patio dining, banquets and buffet dining. Each collection offers a unique style that can inspire and elevate your plating, helping you to create show stopping food presentations.



6959E6135 ●
Platter Rectangle
L 18½" W 10½" H 1¼"



6959E6134 ●
Platter Rectangle
L 14½" W 9½" H 1"



6959E6136 ●
Platter Round
D 14"



6959E6132 ●
Serving Bowl
D 15" H 4" (5qt)



6959E6131 ●
Serving Bowl
D 13" H 4" (3¾qt)



6959E6130 ●
Serving Bowl
D 10" H 4" (2½qt)



6959E6133 ●
Crock
D 6" H 7" (2qt)



6959E6137 ●
Crock
D 5" H 5½" (1qt)

D=Diameter L=Length W=Width H=Height • All Products are Measured at Max Capacity (oz)

● Non-Stock

a buffet presentation that pops

Introducing Alpha-Ceram Buffet, a collection of service items made of fortified porcelain that provide an eye-catching display through dimension & visual appeal. With subtle embossments and a full indigo glaze, these serving vessels are shaped with accentuated curves and bring an added softness to the display. Made of a lightweight, yet durable material, service is easy and clean up is quick & efficient.



slate



Gastronorm Platter
7184TM049A ● 1/1
53.0cm x 32.7cm (21" x 12¾" H 1")
7184TM048A ● 2/4
53.0cm x 16.5cm (21" x 6⅜" H 1")

7184TM047A ● 1/2
32.4cm x 27.0cm (12¾" x 10½" H 1")
7184TM046A ● 1/3
32.4cm x 17.5cm (12¾" x 7" H 1")

Large Round Shallow Bowl
7184TM043A ●
35.9cm x 6.7cm (14⅓" x 2⅔")
4.5Ltr (4¾qts)

Medium Round Shallow Bowl
7184TM041A ●
29.8cm x 6.7cm (11¾" x 2⅔")
2.5Ltr (2⅔qts)



Large Round Bowl
7184TM045A ●
41.3cm x 17.5cm (16¼" x 6⅘") 15.3Ltr (16⅓qts)
7184TM044A ●
35.6 x 14.9cm (14" x 5⅞") 9.1Ltr (9⅝qts)

Medium Round Bowl
7184TM042A ●
28.6cm x 11.7cm (11¼" x 4⅔")
4.5Ltr (4¾qts)

Small Round Bowl
7184TM040A ●
24.4cm x 9.5cm (9⅝" x 3¾")
2.25Ltr (2⅔qts)

stone



Gastronorm Platter
7194TM049A ● 1/1
53.0cm x 32.7cm (21" x 12¾" H 1")
7194TM048A ● 2/4
53.0cm x 16.5cm (21" x 6⅜" H 1")

7194TM047A ● 1/2
32.4cm x 27.0cm (12¾" x 10½" H 1")
7194TM046A ● 1/3
32.4cm x 17.5cm (12¾" x 7" H 1")

Large Round Shallow Bowl
7194TM043A ●
35.9cm x 6.7cm (14⅓" x 2⅔")
4.5Ltr (4¾qts)

Medium Round Shallow Bowl
7194TM041A ●
29.8cm x 6.7cm (11¾" x 2⅔")
2.5Ltr (2⅔qts)



Large Round Bowl
7184TM045A ●
41.3cm x 17.5cm (16¼" x 6⅘") 15.3Ltr (16⅓qts)
7184TM044A ●
35.6 x 14.9cm (14" x 5⅞") 9.1Ltr (9⅝qts)

Medium Round Bowl
7184TM042A ●
28.6cm x 11.7cm (11¼" x 4⅔")
4.5Ltr (4¾qts)

Small Round Bowl
7184TM040A ●
24.4cm x 9.5cm (9⅝" x 3¾")
2.25Ltr (2⅔qts)

light weight, high durability

Creations Pompeii Buffet generates an astonishing and memorable display. Designed for both hot and cold, this melamine collection provides high-quality design with versatility among foodservice presentations. Available in slate and stone colours, Pompeii Buffet is dishwasher safe and its break resistant structure eliminates the need to sacrifice visual quality for durability.



stylish, versatile buffet presentation

Add that something extra to your buffet presentation with the Gastronorm Trays by Creations. Available in a variety of sizes with corresponding covers, these large display platters come in four finishes to suite any occasion including slate, white, spiral, craft and driftwood. Offering style and versatility, the Gastronorm Trays are great for an array of foods while providing a stunning presentation every time.



Cover 1/1
6470ML10
536 x 331 x 91.5mm (21" x 13" x 3½")
Fits EL590, EL591

Cover 1/2
6470ML11
331 x 271 x 91.5mm (13" x 10½" x 3½")
Fits EL596, EL597

Cover 1/3
6470ML12
331 x 182 x 91.5mm (13" x 7⅞" x 3½")
Fits EL592

Cover 2/4
6470ML13
536 x 168 x 91.5mm (21" x 6⅝" x 3½")
Fits EL594, EL595



slate

Pompeii Gastronorm Platter **NEW**
7184TM049A ● 1/1
53.0cm x 32.7cm (21" x 12¾" H 1")
7184TM048A ● 2/4
53.0cm x 16.5cm (21" x 6⅜" H 1")

7184TM047A ● 1/2
32.4cm x 27.0cm (12¾" x 10½" H 1")
7184TM046A ● 1/3
32.4cm x 17.5cm (12¾" x 7" H 1")



stone

Pompeii Gastronorm Platter **NEW**
7194TM049A ● 1/1
53.0cm x 32.7cm (21" x 12¾" H 1")
7194TM048A ● 2/4
53.0cm x 16.5cm (21" x 6⅜" H 1")

7194TM047A ● 1/2
32.4cm x 27.0cm (12¾" x 10½" H 1")
7194TM046A ● 1/3
32.4cm x 17.5cm (12¾" x 7" H 1")



Driftwood Rectangle Platter 1/1
68A351EL590 ● 1/1
530mm x 325mm (21" x 12¾")
68A351EL596 ● 2/4
530mm x 162mm (21" x 6⅜")

Driftwood Rectangle Platter
68A351EL592 ● 1/2
325mm x 265mm (12¾" x 10½")
68A351EL594 ● 1/3
325mm x 176mm (12¾" x 7")



Slate Rectangle Platter
68A415EL591 ● 1/1
530mm x 325mm (21" x 12¾")
68A415EL597 ● 2/4
530mm x 162mm (21" x 6⅜")

Slate Rectangle Platter
68A415EL593 ● 1/2
325mm x 265mm (12¾" x 10½")
68A415EL595 ● 1/3
325mm x 176mm (12¾" x 7")



Craft White Rectangle Platter 1/1
68A416EL591 ● 1/1
530mm x 325mm (21" x 12¾")
68A416EL597 ● 2/4
530mm x 162mm (21" x 6⅜")

Craft White Rectangle Platter
68A416EL593 ● 1/2
325mm x 265mm (12¾" x 10½")
68A416EL595 ● 1/3
325mm x 176mm (12¾" x 7")



Extra Large Round Bowl
68A632EL863 ●
38.1cm x 15.2cm H (15" x 6" H)
11.8Ltr (12½qts)



Large Round Bowl
68A632EL862 ●
33.0cm x 12.7cm H (13" x 5" H)
7.6Ltr (8qts)



Medium Round Bowl
68A632EL861 ●
27.9cm x 10.2cm H (11" x 4" H)
3.8Ltr (4qts)



Small Round Bowl
68A632EL864 ●
22.9cm x 7.6cm H (9" x 3" H)
2.1Ltr (2¼qts)



Square Pebble Bowl
68A632EL866 ●
38.1cm x 8.3cm H (15" x 3¼" H)
4.7Ltr (5qts)



Square Pebble Bowl
68A632EL865 ●
34.3cm x 7.6cm H (13½" x 3" H)
2.8Ltr (3qts)



Square Pebble Bowl
68A632EL867 ●
25.4cm x 3.8cm H (10" x 1½" H)
0.9Ltr (1qts)



Medium Round Platter
68A632EL860 ●
33.0cm x 5.1cm H (13" x 2" H)
3.3Ltr (3½qts)

craft melamine extends to buffet service

Give your buffet an upgrade with these large melamine serving pieces from Creations. Designed to replicate our ever-popular Craft dinnerware collection, this melamine offering is made to withstand the rigours of foodservice and is dishwasher safe. Craft melamine has a neutral colour palette that blends well with existing service items, providing the opportunity for a customers to create a personalised and on-trend presentation.



long-lasting & robust

Reminiscent of a deep blue sky and rocky mountain hillside is the Quarry collection by Creations Melamine. These hearty platters and bowls feature a unique, stone-like decal on a highly durable melamine body and are ideally sized to meet the needs of any buffet presentation.



Bowl
7192TM302A ●
37.5 x 32.1 x 9.2cm (14¾" x 12⅝" x 3⅝")
520.5cl (5½ qts)



Bowl
7192TM301A ●
43.2 x 24.1 x 7.6cm (17" x 9½" x 3")
260.2cl (2¾ qts)



Square Bowl
7192TM300A ●
26.03 x 24.8 x 7.6cm (10¼" x 9¾" x 3")
189cl (2 qts)



V Shape Bowl
7192TM303A ●
25.1 x 25.1 x 15.6cm (9⅞" x 9⅞" x 6⅞")
402.2cl (4¼ qts)



Platter
7192TM304A ●
45.7 x 22.9 x 3.8cm (18" x 9" x 1½")

D=Diameter L=Length W=Width H=Height • All Products are Measured at Max Capacity (oz)

● Stocked in European Warehouse



Plate
68A451EL707 ●
28.0cm Dia (11")



Plate
68A451EL706 ●
23.0cm Dia (9")



Plate
68A451EL705 ●
16.5cm Dia (6½")



Large Oval Platter
68A451EL703 ●
40.0cm x 24.2cm (16" x 9½")



Medium Deep Bowl
68A451EL704 ●
18.0cm x 7.8cm H (7" x 3")
40.0cl (13½oz)



Small Deep Bowl
68A451EL708 ●
13.0cm x 5.3cm H (5" x 2")
15.0cl (5oz)

natural, subtle textures

Inspired by the living elements of a natural landscape, Scape portrays subtle textures and colours that are organically created in nature. Scape offers a free-flowing design with a multi-material approach to transition from casual to formal dining styles and enhances buffet presentations. Available in high alumina vitrified china, melamine, and glass, Scape offers exceptional style, durability, and grace while delivering a genuinely innovative experience.



Cameron Bowl
Shell
KMK1037SH ●
33.0cm (D 13" H 4") (4½qt)



Cameron Bowl
Tortoise
KMK1037TOR ●
33.0cm (D 13" H 4") (4½qt)



Cameron Bowl
Tangerine Pearl
KMK1037TGP ●
33.0cm (D 13" H 4") (4½qt)

unique resin for tabletop & buffet

Kenny Mack Designs features a durable & break resistant resin that is ideal for commercial foodservice. With a multitude of shapes, colours, and sizes, this collection combines functional form and reliability. Inclusive of serving bowls, platters, trays, risers, and more, Kenny Mack resin will elevate any buffet presentation.



Wave Wide Oval Platter
Tortoise
KMK2717TOR ●
61.0cm (L 24" W 14" H 1½")



Wave Rectangle Platter
Tortoise
KMK2805TOR ●
L 21¼" W 9½" H 2½"



Wave Round Bowl
Tortoise
KMK2720TOR ●
45.7cm (D 18" H 5") 2¼gal
KMK2718TOR ●
33.0cm (D 13" H 4") 3¼qt



Wave Shallow Oval Bowl
Tortoise
KMK2721TOR ●
L 19" W 15" H 4"
1 gal



Wave Condiment Bowl
Tortoise
KMK1028TOR ●
12.1cm (D 4¾" H 2¾")
23.7cl (8oz)



Wave Rectangle Platter
Tangerine Pearl
KMK2805TGP ●
L 21¼" W 9½" H 2½"



Wave Round Bowl
Tangerine Pearl
KMK2718TGP ● 33.0cm (D 13" H 4") 3¼qt
Wave Shallow Oval Bowl
KMK2721TGP ● L 19" W 15" H 4" (1gal)



Wave Rectangle Bowl
Tangerine Pearl
KMK2016TGP ●
24.1cm (L 19½" W 10" H 2¼")
3¼qt



Wave Crock
Tangerine Pearl
KMK2934TGP ●
14.0cm (L 5½" H 6½")
94.6cl (32oz)



Wave Condiment Bowl
Tangerine Pearl
KMK1028TGP ●
12.1cm (D 4¾" H 2¾")
23.7cl (8oz)



Wave Oval Bowl
Marine Blue Pearl
KMK2021MBP ●
48.3cm (L 19" W 11½" H 8")
(2gal)



Wave Crock
Marine Blue Pearl
KMK2934MBP ●
14.0cm (L 5½" H 6½")
94.6cl (32oz)



Wave Condiment Bowl
Marine Blue Pearl
KMK1028MBP ●
12.1cm (D 4¾" H 2¾")
23.7cl (8oz)



Wave Oval Tray
Ebony Pearl
KMK2158EBP ●
45.7cm (L 18" W 9¾" H 1¼")



Wave Crock
Ebony Pearl
KMK2934EBP ●
14.0cm (L 5½" H 6½")
94.6cl (32oz)



Wave Condiment Bowl
Ebony Pearl
KMK1028EBP ●
12.1cm (D 4¾" H 2¾")
23.7cl (8oz)



Wave Trough Centerpiece
Grey Ice
KMK2733GICE ● 91.4cm (L 36" W 6" H 4") (1½gal)
KMK2732GICE ● 55.9cm (L 22" W 6" H 4") (3¼qt)



Wave Round Bowl
Grey Ice
KMK2720GICE ●
45.7cm (D 18" H 5") (2¼gal)



Wave Round Bowl
Grey Ice
KMK2718GICE ●
33.0cm (D 13" H 4") (3¼qt)



Wave Round Platter
Shell
KMK2716SH ●
50.8cm (D 20" H 2")



Wave Round Platter
Shell
KMK2165SH ●
35.6cm (D 14" H 1½")



Wide Oval Platter
Shell
KMK2717SH ●
61.0cm (L 24" W 14" H 1½")



Wave Oval Tray
Shell
KMK2141SH ● 61.0cm (L 24" W 12" H 1¼")
KMK2158SH ● 45.7cm (L 18" W 9¾" H 1¼")



Wave Rectangle Platter
Shell
KMK2805SH ●
L 21¼" W 9½" H 2½"



Wave Oval Bowl
Shell
KMK2021SH ●
48.3cm (L 19" W 11½" H 8")



Wave Round Bowl
Shell
KMK2720SH ●
45.7cm (D 18" H 5") (2¼gal)
KMK2718SH ● 33.0cm (D 13" H 4")



Wave Shallow Oval Bowl
Shell
KMK2721SH ●
L 19" W 15" H 4" (1 gal)



Wave Rectangle Bowl
Shell
KMK2016SH ●
24.1cm (L 19½" W 10" H 2¼")
(3¼qt)



Wave Square Bowl
Shell
KMK1044SH ●
35.6cm (L W 14" H 3½")
(4¼qt)



Wave Square Bowl
Shell
KMK1043SH ●
27.9cm (L W 11" H 3")
(2¼qt)



Wave Rectangle Bowl
Shell
KMK2015SH ●
27.9cm (L 11" W 7½" H 2½")
(1qt)



Wave Square Bowl
Shell
KMK1030SH ●
17.8cm (L W 7" H 2¼")
(25½oz)



Wave Crock
Shell
KMK2934SH ●
14.0cm (L 5½" H 6½")
94.6cl (32oz)



Wave Condiment Bowl
Shell
KMK1028SH ●
12.1cm (D 4¾" H 2¾")
23.7cl (8oz)



Wave Trough Centerpiece
Shell
KMK2733SH ●
91.4cm (L 36" W 6" H 4") (1½gal)



Wave Trough Centerpiece
Shell
KMK2732SH ●
55.9cm (L 22" W 6" H 4") (3¼qt)



Jagged Edge Tray
Espresso
KMK2170ES ●
45.7cm (D 18" H 1/2")



Jagged Edge Tray
Espresso
KMK2150ES ●
36.8cm (D 14 1/2" H 1/2")



Oval Bark Bowl
Espresso
KMK2059ES ●
45.7cm (L 18" W 14" H 6 1/2")
(1 1/4gal)



Oval Bark Bowl
Espresso
KMK2082ES ●
33.0cm (L 13" W 10" H 4")
(1 1/2qt)



Royal Palm Bark Tray
Espresso
KMK2058ES ●
48.3cm (L 19" W 5" H 2")



Curved Palm Leaf Tray
Shell
KMK2052SH ●
43.2cm (L 17" W 6 1/2" H 3")



Curved Palm Leaf Tray
Espresso
KMK2052ES ●
43.2cm (L 17" W 6 1/2" H 3")



Jagged Edge Bowl
Espresso
KMK2083ES ●
33.0cm (D 13" H 4 1/2")
(1gal)



Jagged Edge Bowl
Espresso
KMK2084ES ●
26.7cm (D 10 1/2" H 4")
(2qt)



Oval Bark Bowl
Espresso
KMK2081ES ●
25.4cm (L 10" W 8" H 3 1/4")
(1qt)



Jagged Edge Bowl
Espresso
KMK2070ES ●
18.4cm (D 7 1/4" H 3")
(23oz)



Curved Footed Tray
Espresso
KMK2109ES ●
45.7cm (L 18" W 5" H 1 1/4")



Curved Footed Tray
Espresso
KMK2108ES ●
38.1cm (L 15" W 4 1/2" H 1 1/2")



Curved Footed Tray
Espresso
KMK2107ES ●
30.5cm (L 12" W 4" H 1 1/4")



Jagged Edge Tray
Shell
KMK2170SH ●
45.7cm (D 18" H 1/2")



Jagged Edge Tray
Shell
KMK2150SH ●
36.8cm (D 14 1/2" H 1/2")



Oval Bark Bowl
Shell
KMK2059SH ●
45.7cm (L 18" W 14" H 6 1/2")
(1 1/4gal)



Oval Bark Bowl
Shell
KMK2082SH ●
33.0cm (L 13" W 10" H 4")
(1 1/2qt)



Square Charger Tray
Shell
KMK1034SH ●
38.1cm (L W 15" H 1 1/2")



Square Charger Tray
Shell
KMK2139SH ●
33.0cm (L W 13" H 1 1/2")



Square Charger Tray
Shell Marine Blue Pearl
KMK2136SHMBP ●
33.0cm (L W 13" H 1 1/2")

charger



Jagged Edge Bowl
Shell
KMK2083SH ●
33.0cm (D 13" H 4 1/2")
(1gal)



Jagged Edge Bowl
Shell
KMK2084SH ●
26.7cm (D 10 1/2" H 4")
(2qt)



Oval Bark Bowl
Shell
KMK2081SH ●
25.4cm (L 10" W 8" H 3 1/4")
(1qt)



Jagged Edge Bowl
Shell
KMK2070SH ●
18.4cm (D 7 1/4" H 3")
(23oz)



Gallery Rectangle Tray
Shell
KMK2145SH ●
59.7cm (L 23 1/2" W 4" H 1")

gallery



Ripple Oval Tray
Shell Marine Blue Pearl
KMK2139SHMBP ●
33.0cm (L 13" W 4 1/2" H 1 1/2")



Ripple Rectangle Tray
Shell Marine Blue Pearl
KMK2136SHMBP ●
30.5cm (L 12" W 9" H 7")

ripple



Fusion Square Tray
Shell
KMK2800SH ●
L W 12 1/8" H 1 1/4"



Fusion Square Bowl
Shell
KMK2801SH
31.1cm (L W 12 1/4" H 4 3/4")
(1 1/4gal)



Fusion Square Bowl
Shell
KMK2802SH
26.7cm (L W 10 1/2" H 4 1/4")
(3/4qt)



Fusion Square Bowl
Shell
KMK2803SH
20.3cm (L W 8" H 3 1/2")
(1 1/2qt)



Fusion Square Bowl
Shell
KMK2806SH
15.2cm (L W 6" H 2 3/4")
(19oz)



Fusion Square Tray
Tangerine Pearl
KMK2800TGP ●
L W 12 1/8" H 1 1/4"



Fusion Square Bowl
Tangerine Pearl
KMK2801TGP
31.1cm (L W 12 1/4" H 4 3/4")
(1 1/4gal)



Fusion Square Bowl
Tangerine Pearl
KMK2802TGP
26.7cm (L W 10 1/2" H 4 1/4")
(3/4qt)



Fusion Square Bowl
Tangerine Pearl
KMK2803TGP
20.3cm (L W 8" H 3 1/2")
(1 1/2qt)



Fusion Square Bowl
Tangerine Pearl
KMK2806TGP
15.2cm (L W 6" H 2 3/4")
(19oz)



Fusion Square Tray
Tortoise
KMK2800TOR ●
L W 12 1/8" H 1 1/4"



Fusion Square Bowl
Tortoise
KMK2801TOR
31.1cm (L W 12 1/4" H 4 3/4")
(1 1/4gal)



Fusion Square Bowl
Tortoise
KMK2802TOR
26.7cm (L W 10 1/2" H 4 1/4")
(3/4qt)



Fusion Square Bowl
Tortoise
KMK2803TOR
20.3cm (L W 8" H 3 1/2")
(1 1/2qt)



Fusion Square Bowl
Tortoise
KMK2806TOR
15.2cm (L W 6" H 2 3/4")
(19oz)

slant



Slant Bowl
Tortoise
KMK1025TOR ●
20.3cm (D 8" H 6")
(1qt)
KMK1024TOR ●
16.5cm (D 6 1/2" H 4")
(16oz)



Slant Bowl
Tangerine Pearl
KMK1025TGP ●
20.3cm (D 8" H 6")
(1qt)
KMK1024TGP ●
16.5cm (D 6 1/2" H 4")
(16oz)



Slant Bowl
Shell
KMK1025SH ●
20.3cm (D 8" H 6")
(1qt)
KMK1024SH ●
16.5cm (D 6 1/2" H 4")
(16oz)



Slant Bowl
Ebony Pearl
KMK1025EBP ●
20.3cm (D 8" H 6")
(1qt)
KMK1024EBP ●
16.5cm (D 6 1/2" H 4")
(16oz)



Circle Bowl
Tortoise
KMK2086TOR ●
50.8cm (D 20" H 6") (7 1/4gal)



Circle Bowl
Tortoise
KMK2000TOR ●
40.6cm (D 16" H 5") (2 3/4gal)



Circle Bowl
Tortoise
KMK2001TOR ●
34.3cm (D 13 1/2" H 4 1/2") (1 1/4gal)



Circle Bowl
Tortoise
KMK2003TOR ●
25.4cm (D 10" H 4") (3/2qt)



Circle Bowl
Shell
KMK2086SH ●
50.8cm (D 20" H 6") (7 1/4gal)



Circle Bowl
Shell
KMK2000SH ●
40.6cm (D 16" H 5") (2 3/4gal)



Circle Bowl
Shell
KMK2001SH ●
34.3cm (D 13 1/2" H 4 1/2") (1 1/4gal)



Circle Bowl
Shell
KMK2003SH ●
25.4cm (D 10" H 4") (3/2qt)

point



Point Bowl
Espresso
KMK2025ES ●
54.6cm (L 21 1/2" W 8" H 4")
(3qt)



Point Bowl
Espresso
KMK2024ES ●
33.0cm (L 13" W 6 1/2" H 3 1/2")
(1 1/4qt)



Point Bowl
Espresso
KMK2023ES ●
27.9cm (L 11" W 5 1/2" H 2 3/4")
(25oz)



Point Bowl
Espresso
KMK2022ES ●
24.1cm (L 9 1/2" W 4 1/2" H 2")
(10oz)



Point Bowl
Shell
KMK2025SH ●
54.6cm (L 21 1/2" W 8" H 4")
(3qt)



Point Bowl
Shell
KMK2024SH ●
33.0cm (L 13" W 6 1/2" H 3 1/2")
(1 1/4qt)



Point Bowl
Shell
KMK2023SH ●
27.9cm (L 11" W 5 1/2" H 2 3/4")
(25oz)



Point Bowl
Shell
KMK2022SH ●
24.1cm (L 9 1/2" W 4 1/2" H 2")
(10oz)

scoop



Scoop Bowl
Ebony Pearl
KMK1019EBP
34.3cm (D 13 1/2" H 6")
(2gal)



Scoop Bowl
Ebony Pearl
KMK1018EBP
24.1cm (D 9 1/2" H 5")
(3qt)



Scoop Bowl
Tangerine Pearl
KMK1019TGP
34.3cm (D 13 1/2" H 6")
(2gal)



Scoop Bowl
Tangerine Pearl
KMK1018TGP
24.1cm (D 9 1/2" H 5")
(3qt)



Scoop Bowl
Shell
KMK1019SH
34.3cm (D 13 1/2" H 6")
(2gal)



Scoop Bowl
Shell
KMK1018SH
24.1cm (D 9 1/2" H 5") (3qt)

avocado trio bowls



Avocado Trio Bowl
Espresso
KMK2067ES ●
20.3cm (W 8" H 2 1/2")
(7oz each)



Avocado Trio Bowl
Shell
KMK2067SH ●
20.3cm (W 8" H 2 1/2")
(7oz each)



Hollowware & Metal Accessories

Whether it's coffee or water service, canapés or tea sandwiches, your tabletop deserves quality stainless steel hollowware from Steelite International. Our collections perfectly pair with any existing items, and offer a variety of accessory pieces to ensure your table & room service are complete.



beautifully designed, quality made

With a tiered cake stand and three accompanied trays, wine chillers and jugs, the Drift collection offers a range of elegant presentation pieces for your tabletop or buffet. Designed to be both aesthetically unique and highly functional, all Drift items are made from 18/10 stainless steel.



Wine/Champagne Bucket Stand
5977RW003
D 28.0cm H 64.0cm
(D 11" H 25¼")



Wine/Champagne Cooler Large
5977RW020
L 10½" W 16⅞" H 16⅞"



Condiment Servers Set
5977RW006
7.5 x 9.0 x 9.5cm H



Pinch Pot Set w/ Walnut Base
5977RW008
7.0 x 14.0 x 4.0cm H



Double Wine/Champagne Bucket
5977RW002
L 28.0cm W 21.5cm H 23.0cm
(L 11" W 8½" H 9")
Single Wine/Champagne Bucket
5977RW001
L 23.5cm W 19.0cm H 21.0cm
(L 8⅞" W 7½" H 8⅞")



Double Walled Wine/Champagne Cooler
5977RW013
L 13.6cm W 13.4cm H 22.4cm
(L 5⅜" W 5¼" H 9")



Jug w/Ice Guard
5977RW017
L 8⅞" W 6⅝" H 5½"
2L (2¼qt)



Coffee Server
5977RW107 2L (2¼qt)



Jug
5977RW016 300ml (10oz)
5977RW015 150ml (5oz)



Cake Stand
5977RW014
L 24.2cm W 24.2cm H 42.0cm
(D 9½" H 16½")



Two Tier Canapé Stand
5977RW106
H 21.4cm
(L 4⅞" W 4⅞" H 4⅞")

D=Diameter L=Length W=Width H=Height • All Products are Measured at Max Capacity (oz)



stainless steel hollowware

Traditional hollowware is named after its design and style, offering an elegant, yet classic method of coffee and tea service. The solid bar hinges and dripless spouts add that extra appeal for tableside service.



simply designed & durable

Offering insulated coffee, water and tea pots, Tower hollowware is sure to keep your beverage at the right temperature. With solid bar hinges and dripless spouts, Tower is your go-to choice for hollowware.



tear drop

artisanal texture

Reduce the appearance of fingerprints with Tear Drop Hammered Hollowware by D.W. Haber. Comprised of 18/10 stainless steel, the spout and opening resemble a teardrop while the finish is lightly hammered, creating a unique presentation for your tabletop.



D=Diameter L=Length W=Width H=Height • All Products are Measured at Max Capacity (oz)

• Non-Stock



unlimited buffet additions

Complement your foodservice display with a wide selection of buffet accessories. Stainless steel spoon rests, sauce boats, trays and more make up this collection by D.W. Haber.



Round Modern Tray
DW1414P ● D 35.6cm (14")



Bread Tray w/ Applied Border
DW1612 ● L 30.5cm (12")
DW1609 ● L 22.9cm (9")



Tempo Bread Tray
DW1709 ● 25.4cm (L 10" W 5½" H 3½")



Ogee Cash Tray
DW3509 ● 22.9cm x 15.2cm (L 9" W 6")



Rectangle Serving Dish
DW071794SS ● 22.9cm x 11.4cm (L 9" W 4½" H 1½")



Sugar Packet Holder
DW02113SS ● 6.4cm x 4.5cm (L 2½" W 1¾" H 2")



Modern Number Stand
DW04181MSS ● 45.7cm H (L 4" W 4" H 18")
DW04121MSS ● 30.5cm H (L 4" W 4" H 12")



3 Compartment SS Condiment Server Bowls
DW3913 ● 16.5cm (L 6½" W 6½" H 6½")



Caviar Set
DW04955SS ● 5 Bowls w/ Top Ring (W 8" H 6")



Supreme 3 Piece Set w/ Base
DW1001B3 ● (L 5½" W 5½" H 3½")



2 Piece Silver Plate Tea Strainer w/ Cup
DW0497 ●



Ladle Rest
DW396LADREST ● 15.2cm (L 6" W 5¼" H 8¾")



Stackable Sauceboat
DW8011SS ● 24.1cm (L 9½" W 4" H 3¾") 32.5cl (11oz)
DW8008SS ● (L 8¾" W 4¾" H 2¾") (8oz)
DW8005SS ● (L 7½" W 3¾" H 2½") (5oz)



Coaster/Underliner
DW30044 ● D 13.4cm (5¼") 7.6cm (3") Well



Coaster/Underliner
DW30045 ● D 13.4cm (5¼") 10.2cm (4") Well



Flatware Caddy w/ Centre for Cocktail Napkins or Knives
DW0738SS ● 27.9cm (L 11" W 9" H 5")



Satin Universal Cover Holder
DW396CVRHOLD1 ● 27.7cm x 11.4cm (L 11" H 4½")



Satin Adapter Clip to Attach Cover Holder for Wood Fusion Risers
DWFB14CLIPHOLD1 ●



Replacement Fuel Holder
DW01001 ● (L 6¾" W ¾" H 3")



Hammered Spoon Rest
DW394SRM ● 13.4cm (L 5¼" W 3¾" H 3")



Spoon Rest
DW394SR ● 13.4cm (L 5¼" W 3¾" H 3")



Engraved ID Tents Mirror Stainless Steel
DWIDENTCSS ● Coffee L 3¾" W 2¼"
DWIDENTDSS ● Decaf L 3¾" W 2¼"
DWIDENTHSS ● Hot Water L 3¾" W 2¼"
DWIDENTXSS ● Blank L 3¾" W 2¼"

Unlimited options for engraving (ex. Tea, Cream, Milk, etc.)



Stainless Steel Freestanding Card Holder
DW07372SS ● 9.8cm (L 3⅞" W 2⅝")



Black Freestanding Card Holder
DW07372BK ● 9.8cm (L 3⅞" W 2⅝")



Drip Tray w/ Drainer
DW30045SET ● D 13.4cm (5¼")



Square Drip Tray w/ Drainer
DWD RIP5QSETSS ● L W 12.7cm (5")

KENNY MACK DESIGNS *spoon rests*



Curved Spoon Rest Shell
KMK2804SH ● 26.7cm (L 10½" W 4¼" H 2")



Curved Spoon Rest Tangerine Pearl
KMK2804TGP ● 26.7cm (L 10½" W 4¼" H 2")



Curved Spoon Rest Tortoise
KMK2804TOR ● 26.7cm (L 10½" W 4¼" H 2")

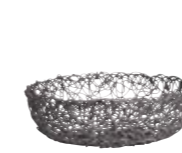

Bronze Finish Basket
7340MW010 ●
23.0cm x 7.0cm H (9" x 2¾" H)
7340MW009 ●
15.75cm x 4.5cm H (6¼" x 1¾" H)

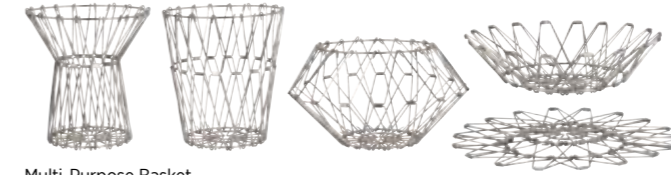

Multi-Purpose Basket
7600CV039 ● 31.8cm x 1.9cm H (12½" x ¾" H) When Folded Flat



Round Satin Sugar Holder
7600CV014 ●
5.0cm x 7.0cm H (2" x 2¾" H)



Rectangle Satin Sugar Holder
7600CV013 ●
8.0 x 6.5 x 4.5cm H
(3⅞" x 2½" x 1¾" H)



Sugar Cube Holder
Hammered Mirror Finish
7340MW013 ●
4.1cm x 4.5cm H (1⅝" x 1¾" H)



Hammered Mirror Finish
Sugar Packet Holder
7340MW006 ●
9.75 x 5.0 x 6.75cm H
(3⅞" x 2" x 2⅝" H)



Mirror Finish Salt & Pepper Set
7600CV001 ●
4.5cm x 8.25cm H
(1¾" x 3¼" H)



Satin Oval Salt & Pepper Set
7600CV002 ●
3.8 x 2.5 x 6.5cm H
(1½" x 1" x 2½" H)



Hammered Rectangular
Salt & Pepper Set
7600CV022 ●
3.0cm x 5.0cm H (1¼" x 2" H)



Angled Salt & Pepper Shaker
7347MW160 ●
4.8cm x 4.4cm H (1⅞" x 1¾" H)
Replacement Stopper
7347MW161 ●
(Fits 7347MW160)



Satin Fry Cup
7600CV006A ●
9.75cm x 7.6cm H
(3⅞" x 3" H) 34.0cl (12oz)



Hammered Fry Cup
7600CV018A ●
10.0cm x 7.25cm H
(4" x 2⅞" H) 34.0cl (12oz)



Hammered Cup
7600CV019 ●
8.5cm x 5.0cm H
(3⅞" x 2" H) 17.0cl (6oz)



Satin Sauce Cup
7600CV010 ● 7.6cm x 4.5cm H (3" x 1¾" H) 15.5cl (5½oz)
7600CV012 ● 5.0cm x 3.8cm H (2" x 1½" H) 5.7cl (2½oz)
7600CV023 ● 3.8cm x 2.5cm H (1½" x 1" H) 4.25cl (1½oz)



Ramekin Satin
7600CV025A ●
6.0cm x 4.1cm H
(2⅜" x 1⅝" H) 5.7cl (2½oz)
7600CV009A ●
6.5cm x 2.5cm H (2½" x 1" H)
5.0cl (1¾oz)



Hammered Ramekin
7600CV024A ●
6.0cm x 4.1cm H
(2⅜" x 1⅝" H) 5.7cl (2½oz)
7600CV008A ●
6.5cm x 2.5cm H (2½" x 1" H)
5.0cl (1¾oz)



Hammered Shallow Bowl
7600CV017 ●
9.75cm x 3.8cm H
(3⅞" x 1½" H) 23.75cl (8½oz)



Trio Snack Holder
7600CV034 ●
17.75cm x 4.5cm H (7" x 1¾" H)
17.0cl (6oz) Each Cup



Satin Creamer
7600CV028 ●
6.5cm x 6.75cm H
(2⅝" x 2⅝" H) 15.5cl (5½oz)
7600CV029 ●
6.0cm x 4.5cm H
(2⅜" x 1¾" H) 10.0cl (3½oz)

metal accessories to fit every niche

From traditional round hammering and rim embossments to stainless steel wire baskets and french fry cups, the Creations Metal collection has it all. Available in various finishes, shapes and sizes, Creations Metal provides that something extra every buffet or tabletop seeks.



Mirror Finish Water Pitcher
7345MW107 ●
20.25cm x 26.6cm H (8" x 10½" H)
398.0cl (3½qts)



Satin Base Insulated Coffee Pot
7502WL002 ●
15.25cm x 22.25cm H (6" x 8¾" H)
145.0cl (51oz)
7502WL001 ●
14.5cm x 18.75cm H (5¾" x 7⅝" H)
96.6cl (34oz)



Stainless Steel Gravy Boat
7350MW201 ●
20.0cm x 11.75cm H
(7⅞" x 4⅝" H) 28.5cl (10oz)



Butter Dish
7347MW136 ●
8.3cm x 5.7cm H (3¼" x 2¼" H)



Satin French Fry Cup
7600CV016 ●
8.75 x 7.0 x 10.75cm H
(3½" x 2¾" x 4¼" H)
37.0cl (13oz)



Fry Basket
7600CV011 ●
10.5 x 9.25 x 6.75cm H
(4⅞" x 3⅝" x 2⅝" H)
(Basket Size w/out Handle)



Wire Fry Cone
7600CV020 ●
8.75cm x 8.75cm H
(3½" x 3½" H)



Satin Taco Holder (For 2 or 3)
7600CV007 ●
15.5 x 8.25 x 3.0cm H
(6⅞" x 3¼" x 1¼" H)



Satin Round Card Holder
7600CV004 ● 3.0cm (1¼")



Satin Square Card Holder
7600CV005 ●
3.8 x 4.1 x 3.5cm H
(1½" x 1⅝" x 1⅝" H)

D=Diameter L=Length W=Width H=Height • All Products are Measured at Max Capacity (oz)

● Non-Stock



eliminate spills & splashes

Make a statement with your beverage service with Royce stainless steel hollowware from Creations. The easy to hold, slanted ergonomic handle allows servers to balance and pour beverages with perfection, while the brushed finish provides a sleek look and reduces the appearance of fingerprints. Royce's tall & slender body will reduce the footprint on the table or buffet, and clever features like longer spouts and ice guards will help eliminate a majority of spills & splashes.

leave a lasting impression

Create an experience guests will remember with the Williamsburg Metalworks Tray collection. These eye-catching trays come in multiple sizes, providing options for table service, room service, and hotel amenities. From the wine coaster to the appetizer platter, these pieces are sure to create a lasting impression.



Coffee Pot w/Long Spout
7347MW153 ●
(2qt)



Water Pitcher w/Ice Guard
7347MW152 ●
(2qt)



Teapot w/Lid
7347MW148 ●
(17oz)



Creamer w/Cover
7347MW145 ●
(9oz)



Sugar Bowl w/Cover
7347MW143 ●
Replacement Lid
7347MW151 ●



Salt & Pepper Set
7347MW147 ●
Replacement Stopper
7347MW149 ●
(Fits 7347MW147)



Round Tray
5851JX35 ● D 40.0cm (15¾") 33.0cm (13") Well
Satin Finish Inside And Mirror Finish On Flange



Rectangular Tray
5851JX32 ● 33.0cm x 25.4cm (13" x 10")
Well 25.4cm x 17.8cm (10" x 7")
Satin Finish Inside And Mirror Finish On Flange



Wine Coaster
5852JX40 ● D 14.6cm (5¾")
Satin Finish



Serving Utensils

Even the serving utensils should bring style and refinement to a buffet presentation. Steelite proudly offers exceptional 18/10 stainless steel collections from Folio & D.W. Haber.



spoons, ladles, tongs and more

No buffet presentation would be complete without its serving utensils. From a clean and sleek look to a fingerprint-free hammered finished, D.W. Haber offers a variety of 18/10 stainless steel utensils that are suitable for foodservice.

chicago serving utensils ★★★★★



DW397CS Pie/Cake Server 25.4cm (10")
DW397SVSPP Slotted Serving Spoon Large 29.2cm (11½")
DW397SVSP Solid Serving Spoon 29.2cm (11½")
DW3979SVSP Serving Spoon Medium 22.9cm (9")
DW3978SVSP Serving Spoon Small 22.9cm (9")
DW397SVFK Serving Fork Large 30.5cm (12")
DW394ICE Ice Scoop 20.3cm (8")

hammered serving utensils ★★★★★



DW398MLAD4 Ladle, Soup/Punch 33.0cm (13") 11.8cl (4oz)
DW398MLAD1 Ladle 30.5cm (12") 3.0cl (1oz)
DW398MPL Pie Lifter 27.9cm (11")
DW398MSVSPP Slotted Serving Spoon Large 33.0cm (13")
DW398MSVSP Serving Spoon Large 33.0cm (13")
DW3981MSVSP Serving Spoon Medium 26.7cm (10½")

roma serving utensils



DW397LADGR Gravy Ladle 16.5cm (6½") 1.5cl (½oz)
DW397LAD1 Ladle 30.5cm (12") 3.0cl (1oz)
DWH397LAD4 Ladle 31.8cm (12½") 11.8cl (4oz)
DW397LAD8 Ladle 35.6cm (14") 23.7cl (8oz)
DW394SVSP Solid Serving Spoon w/ Roma Handle 31.8cm (12½")
DW394SVSPP Pierced Serving Spoon w/ Roma Handle 31.8cm (12½")

tongs



DW396ST9 Serving Tong 22.9cm (9")
DW39468 Serving Tong w/ Notched Ends 20.3cm (8")
DW39462 Ice Tong 17.8cm (7")
DW39461 Sugar Tong 12.7cm (5")
DW398MST10 Hammered Salad Tong 25.4cm (10")
DW398MST9 Hammered Serving Tong 24.1cm (9½")
DW398MST8 Hammered Ice Tong 20.32cm (8")
DW396PST Pastry Scissor Tong 20.32cm (8")

D=Diameter L=Length W=Width H=Height • All Products are Measured at Max Capacity (oz)

• Non-Stock



essential for foodservice

Considered by some to be 'perfection in the hand'. The Radford collection has a softness and ergonomic curve which is both classic and contemporary. The Radford design is versatile enough to complement any table setting. With over 60 pieces, Radford stainless steel flatware and serving utensils offer a solution for any dining occasion.

- | | | | | | | |
|---|---|---|---|--|---|--|
|  Salad Serving Spoon 5970SX062 ● 27.0cm (10.63") |  Serving Spoon 5970SX061 23.0cm (9.06") |  Slotted Spoon 5970SX060 ● (10 ⁵ / ₈ "") |  Gourmet Serving Spoon 5970SX080 ● 25.7cm (10.12") |  Salad Serving Fork 5970SX071 ● 26.4cm (10.39") |  Serving Fork 5970SX072 23.5cm (9.25") |  Pie Server 5970SX031 ● 25.0cm (9.84") |
|  Ice Tongs 5970SX073 ● 17.0cm (6.69") |  Serving Tongs Small 5970SX036 ● 17.3cm (6 ⁷ / ₈ "") |  Serving Tongs 5970SX190 ● 23.4cm (9.21") |  Snail Tongs 5970SX194 ● 17.3cm (6.81") |  Sugar Tongs 5970SX317 ● 10.8cm (4.25") |  Ice Scoop 5970SX188 ● 21.4cm (8.43") |  Stilton Scoop 5970SX265 ● 20.0cm (7.87") |
|  Stilton Scoop (H.H.) 5970SX266 ● 20.0cm (7.87") |  Sauce Ladle 5970SX065 ● 17.0cm (6.69") |  Soup Ladle 5970SX063 ● 32.0cm (12.6") |  Lobster Pick 5970SX028 21.4cm (8.43") |  Napkin Ring Set 2-Piece 5970SX267 ● (2 ³ / ₄ "") | | |



5970SX180 ●
Carving Set



5970SX181 ●
Cheese Knife 5 Piece
Gourmet Set



multi-piece sets

5970SX268 ●
Cheese Set Small
4-Piece 8¹/₄"



ROBERT WELCH *signature 18/10*

All Signature utensils feature comfortable rounded handles with a lipped end. Made from the finest 18/10 stainless steel, each utensil has been designed with its specific purpose in mind and to maximise ease of use. Ideal as a hanging set as well as serving pieces at the table.

- | | | | | |
|---|--|---|--|---|
|  Ladle Large 5979SX063A 32.0cm (12.6") |  Ladle Small 5979SX065A 26.0cm (10.24") |  Serving Spoon Small 5979SX066 26.0cm (10.24") |  Serving Fork Large 5979SX072 33.0cm (12.99") |  Pie/Flan Server 5979SX031 30.0cm (11.81") |
|---|--|---|--|---|



Bryce's stainless steel cutlery features a high quality, 18/10 stainless steel finish and has expanded to a line of serving utensils. With a classic design, create a seamless look from tabletop to buffet with these simply elegant serving pieces.

- 18/10 stainless steel serving utensils
- High quality mirror polished finish
- Modern look, designed for buffet
- Extensive range



The contemporary and unique design of the Angle serving pieces feature a convenient curve on the brushed satin handles that make it easy to hold and perfect for banqueting.

- 18/10 stainless steel
- High quality mirror polished finish
- Brushed satin handle
- Modern design with an elevated handle for ease of use

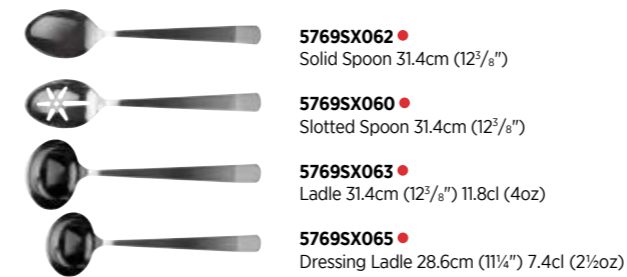



modern and sleek

The Idol™ serving pieces are inspired by the modern styling of Idol™ chafers. The sleek hollow handles dissipate heat keeping them comfortable to the touch even when left in heated food pans. The handles also highlight a convenient, curved design, making it easier to pick up off the table.

durability and style

Made of durable 18/10 stainless steel, Walco Ultra serving utensils feature a classic rim design with long handles and a polished mirror finish. Manufactured to hotel weight standards, Ultra will withstand the rigours of foodservice.

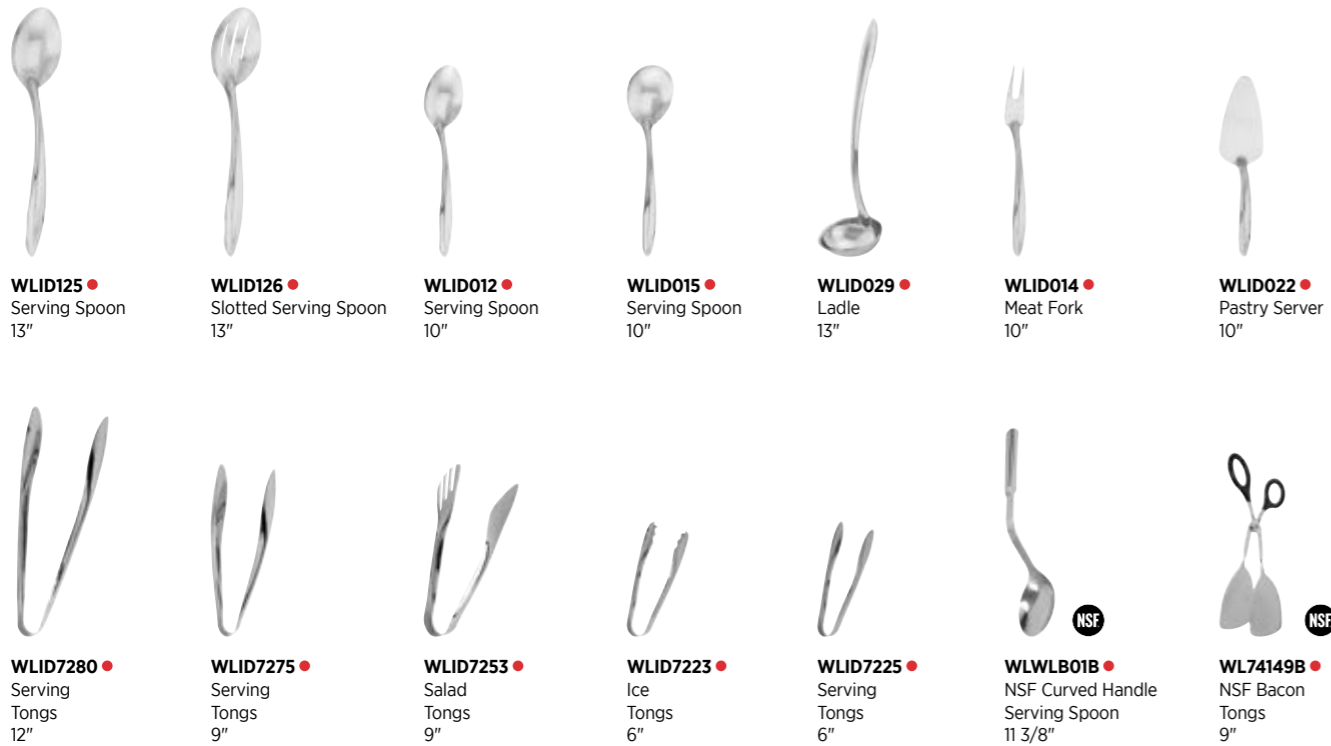



MTPLL011216
Linen Silicone Placemat
Chocolate
30.5cm x 40.6cm (12" x 16")



MTPLL021216
Linen Silicone Placemat
Denim Blue
30.5cm x 40.6cm (12" x 16")



MTPLL071216
Linen Silicone Placemat
Black Grey
30.5cm x 40.6cm (12" x 16")



MTPLST201216
Stream Silicone Placemat
Silver
30.5cm x 40.6cm (12" x 16")



MTPLTW041216
Twine Silicone Placemat
Silver
30.5cm x 40.6cm (12" x 16")



MTPLHA071216
Hatch Silicone Placemat
Black Grey
30.5cm x 40.6cm (12" x 16")



MTPLMA071216
Marble Silicone Placemat
Grey
30.5cm x 40.6cm (12" x 16")



MTTVHI00407
Hive Trivet Midnite
17.8cm (7")



MTTVHI00107
Hive Trivet Cloud
17.8cm (7")



MTTVHI00307
Hive Trivet Graphite
17.8cm (7")



MTTRLI011472
Linen Silicone Table Runner
Chocolate
35.6cm x 182.9cm (14" x 72")



MTTRLI071472
Linen Silicone Table Runner
Black
35.6cm x 182.9cm (14" x 72")



MTTRST201472
Stream Silicone Table Runner
Silver
35.6cm x 182.9cm (14" x 72")

the evolution of a functional linen for tabletop

Modern-twist inspires a better dining experience through design, function, and social responsibility by producing innovative, quality products. Using pure, hand printed silicone, Modern-twist has successfully created a line of placemats, table runners and trivets that are eco-friendly and 100% food safe. Currently used in top hotels, restaurants and airports worldwide, these linens are commercial dishwasher safe, BPA free, and have no memory so they always lay flat. With a look as elegant as cloth and more functional than vinyl, Modern-twist is the perfect addition to your dining room table.

D=Diameter L=Length W=Width H=Height • All Products are Measured at Max Capacity (oz)



Care & Use Guide

Seventy percent of product damage/loss occurs at the dishwasher table. To avoid such damage, ensure that the dishwasher table has sufficient space to store dirty items and avoid overloading trays or trolleys. All items should be separated into type prior to washing. All washing equipment chemicals should be maintained and checked regularly. Check stock often; storage facilities should allow for stock rotation to prevent overuse.



fusion buffet system

TEAK WOOD FINISH

- Not dishwasher safe.
- Use a soft cloth with water to wipe down surface.
- Do not use any chemical products or abrasives.

TEFLON AND STAINLESS-STEEL COATING

- Dishwasher safe.
- Clean in dishwasher or use a soft cloth sprinkled with a few drops of dishwashing liquid to wipe Teflon surface cleans. Wipe off soapy residue with a damp cloth.
- A stainless-steel cleaner can be used to polish stainless steel risers.

TILE INSERTS - RESIN, TEAK WOOD, AND GLASS

- All dishwasher safe, except for wood tiles. Never put wood in the dishwasher.
- Teak wood - wipe down with a soft damp cloth and few drops of dishwashing liquid. Wipe off residue with a soft cloth.
- Resin and Glass – dishwasher safe.

creations wood

To best maintain product finish and condition:

- Do not place near an open flame or grille
- Products should be stored in a dry location at room temperature.
- Do not store near heat sources or in humid places.
- **This product should not be used in the dishwasher, oven, microwave or freezer.**
- Clean with a soft damp cloth or wash with hot soapy water, do not soak in water or wash with harsh detergents.
- Sanitise using an antibacterial spray or food safe liquid sanitiser.

- Dry promptly after cleaning, ensure products are dry before stacking.
- In order to maintain product finish and condition, apply a light coat of mineral oil with a clean dry cloth, to prevent wood from drying and cracking.
- Do not leave in direct sunlight for long periods of time.



kenny mack resin

- Dishwasher and food safe.
- Product doesn't stain however on darker colours a white film may develop over time due to drying agents. If this occurs, wiping the surface with any type of oil will bring back the original colour.

- If any chipping occurs, use light sandpaper or a rough sponge to buff and smooth down the chip.

modern twist

- All products are free of byproducts and fillers.
- No BPA, PVC, lead, latex or phthalates.
- Dishwasher safe on the top rack.
- Keep away from sharp objects.
- To prevent staining rinse or wipe with a damp cloth after each use.
- Do not use chemical sprays.

PLACEMATS

- Hand printed pure silicone, non-porous, food grade and plastic-free.
- High heat resistance up to 425°F / 220°C (not to be used as a trivet).

TABLE RUNNERS

- Silky, non-porous, food grade + germ-free silicone.
- High heat resistance up to 425°F / 220°C (not to be used as a trivet).

TRIVETS

- Pot holder + trivet, the interlocking design turns the trivets into a table runner.
- High heat resistance up to 675°F / 355°C.



melamine

DO

- Melamine products are commercial dishwasher safe.
- Clean as soon as possible to help avoid staining and protein build-up.
- Immediately remove any damaged or chipped melamine products from operational use.
- Melamine products can withstand heat up to 212°F (100°C).

DO NOT

- Do not use in oven, microwaves or expose to direct flame, this can cause cracking and blistering from the heat.
- Do not use with heat lamps, conveyor belts, or plate warmers.
- The use of serrated knives is not recommended on melamine products.
- To avoid chipping and scratching, do not strike melamine products with or on any hard surface while attempting to remove excess food.

DESTAINING

- Periodically presoak melamine products before dishwashing to prevent staining and to maintain lustre.
- For staining, use an oxygen-releasing compound such as Dip-It XP (ECOLAB).
- Sponges or woven plastic pads are recommended for cleaning.
- Do not use harsh or abrasive cleaners, steel wool, or metal pot scouring pads to remove food or stains.

DISHWASHING

- Refer to a qualified technician to establish a maintenance schedule for your dishwashing system to ensure proper temperatures, chemical levels, and mineral content.
- Only use sanitisers developed for commercial use.
- To avoid chipping and scratching, do not overload your dishwasher rack.
- Do not use chlorine bleach or chlorine-based sanitising solutions when caring for melamine products.

Recommended ECOLAB detergents:

- Apex Power Plus (high-temp)
- Apex Ultra (hard water, high-temp)
- Fast Drying Rinse (ideal for plasticware)
- Solid Power XL (high-temp)
- Solid Ultra Klene Plus (low-temp)

Recommended ECOLAB rinse agents:

- Apex HD Rinse Aid (hard water, high-temp)
- Apex Rinse Additive (high-temp)
- Rinse Dry (high-temp)
- Solid Brilliance (high-temp)
- Ultra Dry (low temp)

Recommended ECOLAB sanitisers:

- Eco San (low temp)
- Ultra San (low temp)



folio cookware

- Cast Aluminium provides an unbreakable body, is an excellent heat and cold conductor and is at least 50% lighter than cast iron. Folio Cookware has a 4-Ply ceramic non-stick coating, in which food will release easily from the pan, is easy to clean with warm soapy water and soft cloth or sponge, and no oil or cooking spray is needed.
- All Folio Cookware items can be used in an oven, up to 450°F (230°C). Cooking pots can also be used on electric or gas cooktops, as well as on induction cooking and warming tops.

CROCKS & CASSEROLES



OVEN

COOKING POTS

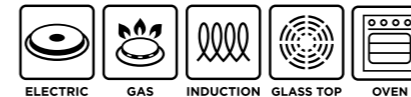

ELECTRIC

GAS

INDUCTION

GLASS TOP

OVEN

While Folio Non-stick Cookware performs better than most non-stick cookware, it is not scratch proof, the life and beauty of the non-stick coating can be prolonged with best care and use practices:

DO

- Do use non-metal serving utensils.
- Do use soft pads or brushes to remove residue before washing.
- Do clean in a dishwasher - high temp/low chemical is best.
- Do separate cookware in dish racks so they do not touch.
- Do always use a thick cloth or oven mitts to handle hot cookware.

DO NOT

- Do not use with knives.
- Do not use with metallic serving utensils.
- Do not use metallic scouring pads, green scrubbers, or abrasive cleaners.
- Do not use in microwave oven.
- Do not season cookware with cooking oils or non-stick sprays.

chafers & marmites

STAINLESS STEEL

- Exterior frame and food pans are dishwasher safe.
- The chafing dish frame and cover may be cleaned with warm, soapy water or in the dishwasher.
- The induction water pan should be hand washed.
- Occasionally the frame may need polishing. Use a stainless-steel cleaner or glass cleaner without ammonia.
- Over time the water pan may accumulate water deposit. This can be removed with a de-liming solution.

HOMESTYLE CAST IRON CHAFERS - TEFLON COATING

- Dishwasher safe.
- Rinse with warm water and use a soft nylon brush to remove stuck-on bits before loading in the dishwasher.

FOOD PANS

- Dishwasher safe.

INDUCTION RANGES

- Not dishwasher safe.
- Avoid abrasive cleaners and scouring pads.
- Allow the surface to cool before cleaning.
- Wipe clean using a soft cloth and mild dishwashing liquid soap. Wipe off soap residue with a damp cloth.



heater stands

- Dishwasher safe.
- For aluminium hot plates and grills, a degreaser can be used to remove black stains from fuel use.

induction range

- Avoid abrasive cleaners and scouring pads.
- Allow the surface to cool before cleaning.
- Wipe clean using a soft cloth and mild dishwashing liquid.
- Wipe soap residue with a soft damp cloth.

heat lamps

- Not dishwasher safe.
- Make sure power is switched off before servicing unit.
- Unplug the unit from the power source.
- Allow lamps to cool before cleaning the unit or replacing bulbs.

- Remove bulbs and use a mild detergent such as dishwashing liquid with a soft sponge or cloth to wipe down.
- Dry with a soft cloth. Completely dry before the next use.
- Do not immerse the unit in water and never use abrasive or scouring powders.

carving boards

WOOD BOARDS

- Not dishwasher safe.
- Hand wash the board immediately after use with water and dishwashing soap.
- Pat the board dry with a paper towel or dishtowel immediately after cleaning.
- To maintain and extend the board life, season weekly, bi-weekly or monthly by wiping food-grade mineral oil over your dry board's exterior. Let the oil sit for a few hours. Wipe off excess oil with a dry cloth.

- Never use olive or vegetable oil to season a carving board.

WHITE POLY BOARD Dishwasher safe

BLACK GRANITE Dishwasher safe



beverage urns, milk & cereal dispensers

JUICE & BEVERAGE URN, MILK DISPENSER

- Components are not dishwasher safe.
- Do not use abrasive products.
- **Daily:**
 - Remove nozzles and diffusers and soak them in warm, soapy water.
 - Use hot water and mild soap to clean inside of dispenser and then rinse thoroughly.
 - Clean outside with a warm wet cloth.
 - Clean spigot by removing rubber seat cup and clean by brushing inside of faucet.
- **Regular Basis:**
 - Flush and clean water lines.

- Never immerse base of Urn in water.
- Clean spigot by removing rubber seat cup and clean by brushing inside of faucet.
- Tip - Use rubber gloves to ensure the faucet is tight when you screw it back on to prevent leakage.
- **De-Staining**
 - Put 1 cup baking soda into your stainless-steel coffee pot and fill with warm water.
 - Use a dish brush to scrub inside of the pot with baking soda solution in it.
 - Pour solution out and thoroughly rinse inside with hot water until it runs clean.

COFFEE URN

- **Cleaning**
 - Always rinse urn immediately after each use.
 - Add a small quantity of hot water, brush insides, and rinse with hot water.

CEREAL DISPENSER

- Disassemble all parts and clean interior with warm soapy water, rinse thoroughly.
- All parts should be completely dry before reassembling.

stainless steel display items (cold buffet & wine)

- Dishwasher safe.
- Do not use steel pads, wire brushes or scrapers. Do not use powders, or cleaners that contain chlorides, bromides or iodides.
- Always rinse thoroughly with fresh water after every cleaning operation.
- Wipe unit dry with a soft cloth to remove water.
- Always rub in the direction of the steel grain for maximum effectiveness to avoid marring the surface.
- For smears or fingerprints, wipe with a clean slightly damp cloth. If that doesn't work, use a stainless-steel commercial cleaner.



china

- Should be washed within 45 minutes of removal from the table and pre-rinsed.
- Avoid contact between china, dinnerware and metals.
- Abrasive cleaning aids should not be used, i.e. scouring pads, steel wool, etc.
- Minimise handling to reduce glaze abrasion.
- Do not stack more than 15" high.
- Do not slide items across each other to reduce abrasions.

- Be sure to rotate your stock to prevent uneven wear.
- Only stack product that are designated stackable.

CUSTOM DECORATED CHINA

- Gold and platinum decorations are not microwave safe.
- Hand washing is recommended to prolong the metallic lustre of decoration.

glassware

- After washing, remove basket and leave to cool and dry.
- Never carry glasses in bouquets.
- Never use glass to carry or store cutlery.
- Never let the beer tap come in contact with the glass.
- Do not use glassware as an ice scooper.
- Use properly sized compartmented glass racks.

stemware

- Do not handle the stemware when hot.
- Use white cotton gloves or 2 cloths for polishing
- Polish the bowl first followed by the stem and then the base.
- Do not hold the glass by the stem or the base when polishing the bowl.
- Use properly sized compartment glass racks.

aspen & strahl drinkware

- Dishwasher & freezer safe.
- Items must be carefully placed in the dishwasher while avoiding direct contact with other dishes and drinkware.
- Do not wash with harsh abrasives such as brushes or scrubber pads as this may cause scratches; harsh chemicals including strong acid or alkali cleaning agents should also be avoided.
- Use warm, soapy water or a neutral dishwashing liquid for cleaning.
- Dry naturally or with a soft cloth after hand washing; we recommended using a microfibre cloth to preserve clarity.

- Product can be used normally between temperatures of -30°C and 110°C (-22°F and 230°F).
- Avoid prolonged exposure to UV light, sunscreen or chlorine.
- Not recommended for use in microwaves or high temperature sterilisers.

POLYPROPYLENE LIDS, STOPPERS & BOTTOMS

- Do not use strong acid or strong alkaline cleaning agents.
- Temperature should not exceed more than 104°F (40°C).
- Avoid excessive water pressure as well as objects pressing on the product or it may cause deformation.



cutlery

- Cutlery should be washed separately from dinnerware.
- Wash as soon as possible to prevent pitting from acidic food deposits.
- A pre-soak in warm water is recommended to loosen food particles.
- Make sure your cleaning agent is void of any abrasive or corrosive qualities.
- Use upright baskets to prevent scratching and to aid drying.



- Do not overfill the upright cutlery baskets.
- If using a low temperature dishwashing system, carefully follow the manufacturer's instructions to avoid staining or corrosion.
- On completion of the wash, allow the cutlery to air dry, hand dry if necessary.
- Be sure cutlery is completely dry before storing in a dry location away from the kitchen.

steak knives

WOOD HANDLED KNIVES

- Handwashing is recommended for the best performance and optimal product life.
- Wash knives with warm water and a mild detergent, rinse well and dry thoroughly.
- Water and harsh detergents will dull the finish and dry out the handles.
- It is recommended that the wooden handles be oiled as needed.

ABS (RESIN) HANDLED KNIVES

- Low temp dishwasher safe.
- Wash knives with warm water and a mild detergent, rinse well and dry thoroughly.
- Not recommended for high temp dishwashers that exceed 167°F / 75°C.
- Knives should not be exposed to extreme temperature changes, which will cause the abs handle material to crack over time.

STAINLESS STEEL KNIVES

- Dishwasher safe.
- Wash knives with warm water and a mild detergent, rinse well and dry thoroughly.

BLADE SHARPENING

- Serrated blades cannot be sharpened.
- Blades with no serrations can be sharpened as needed.
- The frequency will depend on how often the knives are used and how well they are maintained.

THINGS TO AVOID

- Avoid soaking knives; they should be cleaned immediately after use to prevent damage caused by certain foods.
- Avoid using abrasive cleaners, scouring pads, oven cleaners or cleaners containing chlorine bleach or citric extracts.
- Avoid cutting on hard surfaces such as stone, metal or glass.

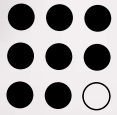

steelite

INTERNATIONAL

Benelux

Steelite International Benelux BV
's Gravelandseweg 258
3125 BK Schiedam
Nederland
Telephone +31 (0)20 617 5915
Email info@steelite.nl

Germany

Steelite International
Deutschland GmbH
Philipp-Reis-Straße 16
64404 Bickenbach
Telephone +49 (0)6257 61950
Email germany@steelite.com

France

Telephone +33 682 574 291
Email france@steelite.com

Italy

Telephone +39 0522 902051
Email italy@steelite.com

Portugal

Rua Brito Pais, 4C - Loja - Miraflores
1495-028 Algés
Telephone +351 215 839 333
Mobile +351 918 550 429
Email jq@hotelrestaurantco.com

Scandinavia

Telephone +46 730 322 818
Email scandinavia@steelite.com

Spain

Steelite International Spain
Médico Andrés Boldó, 2
03005 Alicante
Telephone +34 966 590 300
Email spain@steelite.com

Madrid Showroom

Calle Serrano, 27, 6th Floor,
28001 Madrid
Telephone +34 910 400 870
Email madrid@steelite.com

Russia, Central & Eastern Europe

CECUK Ltd
Coleridge House, Suite 47
2-3 Coleridge Gardens
London, NW6 3QH
Telephone 0044 207 435 9033
Mobile 00777 613 5088
Email rcee@steelite.com



www.steelite.com

f steeliteinternationalEMEA

X steeliteEMEA

@ steelite_emea

Showrooms available by appointment:

Atlanta • Bickenbach, Germany • Chicago • Hong Kong • London, UK • Los Angeles • Madrid • Miami
New York • Stoke-on-Trent, UK • Sydney, AUS • Toronto, ON • Washington, D.C. • Youngstown, OH